3D Frequently Asked Questions

Compiled from the 3-D mailing list

This document was compiled from postings on the 3D electronic mail group by:

Joel Alpers

For additions and corrections, please contact me at:

Joel.Alpers@FtCollinsCO.NCR.COM

This is Revision 1.1, January 5, 1995

The information in this document is provided free of charge. You may freely distribute this document to anyone you desire provided that it is passed on unaltered with this notice intact, and that it be provided free of charge. You may charge a reasonable fee for duplication and postage.

This information is deemed accurate but is not guaranteed.

Table Of Contents

1	Introduction	7
1.1	The 3D mailing list	7
1.2	3D Basics	7
2	Useful References	7
3	3D Time Line	8
4	Suppliers	9
5	Processing / Mounting	9
6	3D film formats	9
7	Viewing Stereo Pairs	11
7.1	Free Viewing - viewing stereo pairs without special equipment	11
7.1.1	Parallel viewing	11
7.1.2	Cross-eyed viewing	11
7.1.3	Sample 3D images	11
7.2	Viewing using 3D viewers	11
7.2.1	Print viewers - no longer manufactured, available used	11
7.2.2	Print viewers - currently manufactured	12
7.2.3	Slide viewers - no longer manufactured, available used	12
7.2.4	Slide viewers - currently manufactured	12
8	Stereo Cameras	13
8.1	Currently Manufactured	13
8.2	Available used	13
8.3	Custom Cameras	13
8.4	Other Techniques	19
8.4.1	Twin Camera	19
8.4.2	Slide Bar	19
8.4.3	Beam Splitters	19
9	Anaglyphs	20
10	Lenticular Photography	21
11	Slide Mounting / The Stereo Window	21
12	Projection	21
13	Close-up Photography	21
13.1	Macro 3D Basics	21
13.2	Base Separation for twin-camera macro photography	22
13.3	Convergence / Keystoning	22
14	Photomicrography	23
15	Aerial Photography	24

16 Astrophotography	24
16.1 The Moon	24
16.2 Astronomy 3D Articles	25
16.3 Other Astrophotography topics	25
17 HyperStereo	25
18 Shutter / Flash Synchronization	25
19 Special Effects	26
19.1 Time Exposures	26
19.2 Stop Action Photography using an audio flash trigger	26
19.2.1 Sound Trigger II	27
19.2.2 Simple Sound Trigger	29
19.2.3 Other audio strobe possibilities	30
20 3D Video	30
20.1 Alternate-frame Video	30
20.2 Anaglyph Video	30
20.3 The Pulfrich Effect	30
20.4 IMAX 3D	31
21 Stereo Clubs / Associations / Periodicals	32
Appendix A: Film Image Format	33
A.1 Standard 35mm film dimensions	33
A.2 View-Master	33
A.3 Nimslo / Nishika (4 lenses) - 4 sprocket (24 x 18)	33
A.4 Image Tech 3d Magic and 3d Wizard (3 lenses) - 4 sprocket (28 x 18)	34
A.5 Image Tech Professional (5 lenses) - ???	34
A.6 Realist - 5 sprocket (24 x 23)	34
A.7 European - 7 sprocket (24 x 30)	34
A.8 Half-Frame - side-by-side on 8 sprocket ($\frac{1}{2}$ of 24 x 36)	35
A.9 Standard 35mm - 8 sprocket (24 x 36)	35
Appendix B: Information available via anonymous ftp	36
Appendix C: User's comments on stereo cameras	37
Appendix D: Quotable Quotes	37
Appendix E: Depth of Field Charts	38
E.1 Interocular Separation for Close-up Photography	38
E.2 Linhoff Universal Depth of Field Chart	38
Appendix F: Archives of articles in the 3-D mailing list	39
Appendix G: 3d email list camera measurements	40

Appendix H: Camera Repairs / Maintenance / Modifications	41
H.1 Kodak Stereo Camera	41
H.1.1 Procedure: Removing the top of the camera	41
H.1.2 Modification: Flash adapter	41
H.1.3 Procedure: Kodak slow shutter mechanism	41
H.1.4 Procedure: Adjusting lens infinity focus	42
H.1.5 Procedure: Lens alignment - vertical	42
H.1.6 Procedure: Dismantling the Kodak Stereo	43
H.1.7 Procedure: Problems with the cable-release	44
H.2 Realist Camera	45
H.2.1 Sources for Realist Parts and Repair Information	45
H.2.2 Procedure: Light leaks - camera back	45
H.2.3 Procedure: Film advance clutch spring replacement	46
H.3 Realist Viewer	47
H.4 Nimslo Camera (Japanese-made model)	47
H.4.1 Procedure: Removing the camera bottom	48
H.4.2 Procedure: Removing the camera top	48
H.4.3 Procedure: Fixing problem causing completely unexposed rolls of film ..	48
H.5 ViewMaster Camera	48
H.5.1 Modification: Adapting a ViewMaster for Electronic Flash	48
H.6 Busch VerascopeF40 Camera	49
H.6.1 Procedure: Reduction of internal reflections	49
H.7 Sputnik Camera	50
H.7.1 Procedure: Shutter Adjustment	50
H.8 Twin Camera Arrangements	50
H.8.1 Nikon Lite-Touch	50

3D Frequently Asked Questions

1 Introduction

1.1 The 3D mailing list

The 3D mailing list is a group of individuals who discuss 3D photography and closely allied subjects via electronic mail. An article posted to the group will literally be read by and get responses from a worldwide audience. This list of frequently asked questions about 3D has been compiled from discussions on the 3D mailing list, and other sources. Whenever possible, credit has been given to the sources used.

To subscribe to the 3D mailing list, send email to "listserv@bobcat.etsu.edu", with the text "subscribe photo-3D *your name*" in the body of the email. An email introduction to the group will be returned to you. To report errors in this document or to suggest additions or changes, email to "Joel.Alpers@FtCollinsCO.NCR.COM" with the appropriate information.

1.2 3D Basics

3D photography duplicates the way we view a 3D object or scene by taking a pair of photographs separated by a distance equal to the separation between a typical person's eyes. The two pictures then have a viewpoint similar to the view seen by the left and right eye. These images, if directed to the left and right eyes, are fused by the brain into a single image with the appearance of depth. Perhaps the most well-known example of this is the View-Master many of us have played with as children (of all ages).

2 Useful References

Reference books and materials recommended by the members of the 3D mailing list include:

Reference	Authors	ISBN #	Comments
Reel 3D Commonly Asked Questions	Reel 3D Enterprises, Inc.	n/a	Although many of these questions are covered here, this is a good list of common questions and their answers. You may get a copy by requesting a Reel 3D catalog (see <i>Suppliers</i> section for address)
The World of 3-D	Jacob G. Ferwerda		Available from the publisher: 3-D Book Productions P.O.Box 19 9530 AA Borger The Netherlands The book is printed in English only.
Optics in Photography	Rudolf Kingslake	0-8194-0763-1	"The best technical book for the general audience" - John Bercovitz
Back-issues of the Reel 3D Newsletter (1978, 1979, 1980)	Compiled by David Stark and Susan Pinsky		Available as bound reprints from Reel 3D Enterprises in sets for each year.
Camera Technology (The Dark Side of the Lens)	Norman Goldberg	0-12-287570-2	This is a good book on cameras that's sort of mid-level or less as far as how technical it is. - John B.

3 3D Time Line

Hal Layer contributed this 3d historical time line:

Time Period	Person	Discovery
300BC - 175AD	Euclid Claudius Galen	Each eye sees objects differently
1519	Leonardo da Vinci	Binocular vision adds a quality of relief to the perception of objects.
1611 & 1613	Johann Kepler Francois Aguilonius	Binocular vision is single only at the plane of and convergence; otherwise, images are doubled.
1738 & 1759	Robert Smith W. Porterfield	Binocular parallax causes image disparities.
1775	Joseph Harris	Binocular parallax causes relief perception
1833	Charles Wheatstone	Image disparities, the result of parallax, are the source of relief perception--or stereopsis.
1833	Charles Wheatstone	Binocular images can be drawn
1838	Charles Wheatstone	Space can be perceived inverted (pseudostereo).
1841	Charles Wheatstone	Binocular images can be made photographically
1857	Hermann Helmholtz	The space in binocular images can be scaled (hyperstereo and hypostereo).

To me, the last concept is (or can be) the basis for a new direction for the artist in exploring visual space. I discussed this in Exposure *

* "Stereoscopy: Where Did It Come From? Where Will It Lead?", Exposure 17, No. 3, 34-48, Fall 1979 "Holographic and Stereoscopic Space -- New Research Directions" LEONARDO: INTERNAT'L J. OF CONTEMP. ARTIST: V. 22, Nos 3&4: 411-413, 1989

If you are interested in the Exposure or Leonardo articles, but cannot find them, send a SASE with 52 cents postage to:

H. A. Layer
AV/ITV San Francisco State University
1600 Holloway Avenue
San Francisco, CA 94132 USA

4 Suppliers

Name	Address/Phone	Comments
Reel 3-D	P.O. Box 2368 Culver City, CA, 90231 (310) 837-2368 (310) 558-1653 FAX (orders only)	Large line of 3d slide mounts, slide and print viewers, reference materials, View-Master, cameras, equipment, etc.
"3D Products and Services"	maintained by Tim Klein (klein@cis.ohio-state.edu)	An excellent and very comprehensive list of suppliers of 3D equipment and services. This list (in ASCII format) may be obtained by anonymous ftp from bobcat.etsu.edu

5 Processing / Mounting

The following labs currently do processing and mounting of 3D slides. If you do your own mounting, you may find it useful to take your film to a convenient local lab and mark:

"Process only - do not cut - do not mount"

Lab Name	Address	Comments
Kodalux		
(Reel 3D list)		Reel 3D maintains a list - send them a SASE with a request for it.
See also: "3D Products and Services" list (Refer to Table 2 for info)		

6 3D film formats¹

Several formats are currently in use for 3D photography, as shown in the following table:

Also, see Appendix A for drawings of film formats.

1. Sources: Reel 3D catalog, members of 3D mailing list

Note: All dimensions in mm unless otherwise noted.

Format Name	Film Dimensions	Exposures on roll of:		Slide Mounts		Comments
		135-20	135-36	Opening Size	Mount Size	
View-Master	12 x 13	37	69	10.64 x 11.72	3 17/32" (90mm) diameter circle holding 7 pairs	Interocular 64.90
Bruguere	?	?	?	12 x 13	?	
Tru-View	?	?	?	14.36 x 13.24	?	Interocular 63.64
Nimslo / Nishika	24 x 18	10	18	22 x 16	1 5/8" x 4"	4 side-by-side half frame images. Slide mounts hold 2 of the 4. Designed for special lenticular print
Half Frame	24 x 18, side-by-side on a 35mm frame	20	36		n/a	Typically produced by a beam-splitter arrangement
Realist	24 x 23	16	29	23 x 21.7	1 5/8" x 4"	Normal (7" stereo window)
				23.6 x 21.4	1 5/8" x 4"	Aluminum normal mount
				23 x 21	1 5/8" x 4"	Medium (4" stereo window)
				23 x 19.6	1 5/8" x 4"	Close-up (2 1/2" stereo window)
European	24 x 30	?	21	23.5 x 28	1 5/8" x 4"	
Twin 35mm	24 x 36	10	18	23 x 35	1 5/8" x 4"	When mounted in European format slide mounts
				23.5 x 28	2" x 2"	When mounted in separate 35mm slide mounts
				23 x 33	2" x 4 1/2"	Reel 3D "full frame" mount
Twin 2 1/4"	Mamiya - 56 x 56 Fuji 6x7 - 54.4 x 67.1 6cm x 6cm, 6cm x 7cm	n/a	n/a	n/a	n/a	from 120 or 220 rollfilm
Twin 4x5	3 3/4" x 4 3/4"	n/a	n/a	n/a	n/a	from 4x5 sheet film

7 Viewing Stereo Pairs

7.1 Free Viewing - viewing stereo pairs without special equipment

Free viewing of stereo pairs refers to viewing two photos, drawings, etc. to see a 3D effect without using a viewing device to assist the eyes in “fusing” the two images together. Two basic methods may be used:

7.1.1 Parallel viewing

Pairs of stereo images for parallel viewing have the left image placed on the left side, and the right image on the right. To view, “defocus” your eyes in a manner similar to day-dreaming. After a time you will begin to see “double” images. If you begin to concentrate on the images in the center of your view, you should be able to get them to merge into a single 3D image.

7.1.2 Cross-eyed viewing²

Pairs of stereo images intended for cross-eyed viewing have the image intended for the left eye on the right side, and the right eye on the left side. To view a picture in stereo, display it in its entirety and cross your eyes so that the two halves of the image merge. It is often helpful to over-cross the eyes and let them relax somewhat until the scenes merge into a stereo view. Concentrate your attention on some prominent feature of the scene, preferably in the distance, and get these to merge first. Once full merging takes place you will be able to move your eyes around the scene at will.

Don't be discouraged if you don't achieve the stereo effect easily. Some people have more trouble than others, but cross-viewing is a skill that nearly everyone can learn. If you are new to the technique, don't overdo it. Crossing the eyes tires muscles that are not used to being treated that way. Take frequent breaks until you have built up muscle strength through this unusual exercise. (You will not hurt your eyes in the process.)

(Note: I first learned to parallel free-view images, and had become quite quick at it by the time I first tried to cross-eye view an image. As a result, I had considerable trouble - I found that an aid which helped me was to use a pencil or other object held a short distance in front of the stereo pair. By focusing on this, I was able to get my eyes to cross at approximately the right angle - ed.)

7.1.3 Sample 3D images

If you have trouble finding images to practice on, or if you just want to look at some, check out the color GIF image files Duane Starcher has collected. They are available by anonymous ftp from [morgan.ucs.mun.ca](ftp://morgan.ucs.mun.ca) (134.153.2.99) in the directory “/pub/stereo”. These are cross-eyed view images.

7.2 Viewing using 3D viewers

7.2.1 Print viewers - no longer manufactured, available used³

There are relatively common aluminum-hooded viewers available used which were manufactured around the turn of the century. They often have the imprint of one of the big 3: Underwood&Underwood, Keystone, or HCWhite (which called its scopes “Perfecscopes”) on the hood or on the underside of the tongue near the handle.

Condition is an important consideration. Is the original felt intact? Details can be significant too: often, the folding handle is unsteady. Certain locking designs in the handle are better, in my opinion. I've seen “tiger's maple” quoted as a premium consideration, but I believe that usually refers to a wooden-hooded model. And still, I think the distinction may be overrated.

2. Thanks to Duane Starcher for this excellent description!

3. Thanks to khamilto@houyhnhnm.prime.com, from which much of this was paraphrased.

Unusual, older models rate higher prices if in good condition. A pedestal model with the Joseph Bates blind-stamp could easily be worth \$150. But the older models are less generally useful than the later models which have superior optical qualities.

Beware also that some "reproductions" of the metal-hooded viewers are out there, easily distinguished from the real thing.

These viewers hold a 3 1/2 x 7" card, with two 3" square photos on it.

7.2.2 Print viewers - currently manufactured

Check the Reel 3D catalog - they stock a number of viewers for 3D print pairs. They generally fall into these categories:

1. Fold-flat viewers
2. Single piece - these are a one-piece plastic handle with two lenses molded into it.

7.2.3 Slide viewers - no longer manufactured, available used

Numerous models and brands of viewers for Realist and European format have been manufactured. I will attempt to provide some information when I can dig it up regarding models, features, approximate current availability and costs, etc.

7.2.4 Slide viewers - currently manufactured

Again, check the Reel 3D catalog. They stock both "steal-the-light" viewers, which must be held up to a light or window, and battery-operated lighted viewers. You can buy viewers for Realist/European format, or for twin 35mm mounted slides.

8 Stereo Cameras

8.1 Currently Manufactured

The cameras in Table 5 are currently available new.

Note: Costs are approximate, for information only.

8.2 Available used

The cameras in Table 6 are no longer available new. Many can be found in the used market, however. Possible sources to check are camera stores carrying used equipment, photography swap meets, flea markets, or the listings in *Shutterbug* magazine. The list "*3D Products and Services*" (See Table 2) also lists dealers which regularly sell used stereo cameras. Many of these cameras are circa 1950.

8.3 Custom Cameras

Custom 3D cameras are usually produced by the creative merging of two production cameras (usually 35mm).

Commercially, there is a company in Germany which merges two Ricoh cameras into a single stereo camera. (anyone have Company Name, address, other info?)

Table 1: Stereo Cameras currently available new

Model	Format	Approx. Cost	Lenses	Focusing	Shutter Speeds	Sync. Flash	Film Counter	Double Exp		Features
								Prevent	Capable	
FED Model M	European	\$389	38mm, f/2.8	manual	$1/30$ - $1/500$, B	Y				Russian made. Fully automatic exposure w/ some manual overrides. 220V/50hz projector available. US version of projector in progress.
ImageTech 3D Magic	Half Frame	camera \$15 film proc \$14	3 lens - 27mm f/9.5 fixed	fixed focus	fixed?	Y				World's first single use stereo camera - loaded with 16 print length of ASA 400 film. Standard flash hot-shoe. Weight 4.3 oz. (120 gm.)
3D Wizard	Half Frame (17.4x24)	approx \$50	3 lens - 30mm f/5.6	fixed focus (@ 2 meters)	$1/100$ fixed	Y	Y			Re-load-able, 3 apertures (Mr. Sun, Sun w/ clouds, Mr. Cloudy) (f/16, f/9.5, f/5.6) Built in electronic flash good from 3.5 - 11 ft., powered by two AA cells (rest of camera is completely mechanical). Thumb wheel film advance, rewind knob. 16 exp. on 135-24, 24 exp on 135-36 film.
Professional	??		5 lens - ??mm							Uses 220 roll film
Loreo	Half Frame	\$120		fixed focus						Relies on print film latitude - two apertures ("Mr. Sun" and "Flash"). Includes viewer for $3\frac{1}{2}$ x 5 prints.
Teco-Nimslo	Nimslo/ Nishika									Technical Enterprises bought a bunch of new Nimslo cameras and modified them to take only two half-frames instead of the usual four. See the "3D Products and Services" list for their address.
Nishika	Nimslo / Nishika	\$200	4 lens - 30mm f/11	fixed focus	$1/60$ fixed					
Setzer 6x6	Uses 120 rollfilm in a 6x6 cm format	(lots)	55mm f/4.5	manual with reflex finder, fixed focus > f/8	1 - 1/500	Y	Y			Custom made by Wolfgang Setzer. Shutters synchronized (electromagnetically actuated). Window on camera back for exposure counting. Bubble level. Weight 3.5 Kg. Manual shutter cocking and f/stop setting on the lenses. Mamiya lenses.
6x7	Uses 120 rollfilm in a 6x7 cm format		47mm							

Table 2: Stereo Cameras no longer manufactured, available used

Model	Format	Estimated # ^a Manufactured	Approx. Cost	Lenses	Focusing	Shutter Speeds	Sync.Flash	Film Counter	Double Exp		Coupled film/shutter	Depth of Field Scale	Features
									Prevent	Capable			
Attiscop	??												Glorified box camera. Uses 120 film.
Belpasca	European	8,000	\$1000	37.5mm f/3.5	manual	1s - 1/200. B							
Blair Hawkeye													
Burdlo	Modified Nimslo/Nish-ika												Modified Nimslo (by David Burder) to take two full-size images instead of four half-frames
Busch Verascope F40	European		\$600	40mm f/3.5	rangefinder	1s - 1/250. T, B	Y	Y	Y	Y	Y		Stereo or single frame
Challenger Stereo	Realist			35mm f/3.5	manual	1/10 - 1/100. T, B	M,F						focusing scale, stereo or single frame
Delta Stereo	Realist				fixed focus @ 5,8,10,12,or inf.	1/25 - 1/100. B	Y	Y	Y	Y	Y		single frame capable.
Edixa Stereo IA	Realist			35mm f/3.5	manual	1/25 - 1/200. B	Y	Y	Y	Y	Y		3' min. focus, film advance lever
IB	Realist			35mm f/3.5	manual	1/10 - 1/200. B	Y		Y	Y			
IIA	Realist			35mm f/3.5	rangefinder	1/10 - 1/200. B	Y	Y	Y	Y	Y		same as 1B, with self timer
IIIA	Realist			35mm f/3.5	rangefinder	1/10 - 1/300. B	Y	Y	Y	Y	Y		same as 1B, with self timer, exposure meter
Haneel	??? 828 film												viewer, 6 stereo or 12 mono per 828 roll
Iloca I	European												Factory built custom camera.
II	Realist	30,000	\$180	35mm f/3.5	manual	1s - 1/300. B	Y	Y	Y	-	Y	Y	self timer, all controls coupled
Rapid	Realist	10,000	\$180	35mm f/3.5	manual	1/25 - 1/200. b	Y	Y	Y	Y			Also sold as the Realist 45.
Kin-Dar	Realist	6,000		35mm f/3.5	rangefinder	1/10 - 1/200. B	X	Y			Y	Y	flash exposure scale
Kodak Stereo	Realist	110,000	\$110	35mm f/3.5	manual	1/25 - 1/200. B	XM F		Y				bubble level, film type indicator
Linex	54x59			32mm f/6.1	fixed	1/50 fixed							20 ms shutter delay, stereo or single frame

Table 2: Stereo Cameras no longer manufactured, available used

Model	Format	Estimated # ^a Manufactured	Approx. Cost	Lenses	Focusing	Shutter Speeds	Sync.Flash	Film Counter	Double Exp		Coupled film/shutter	Depth of Field Scale	Features
									Prevent	Capable			
Nimslo	Nimslo/Nish-ika		\$100	30mm f/5.6 (4 lenses)	fixed focus	$1/30 - 1/500$	Y	Y	Y	Y			fully automatic, manual film winder
Owla	Realist	1,000											
Revere 33	Realist	30,000	\$180	35mm f/3.5	rangefinder	$1/2 - 1/200, T, B$	Y	Y	Y	Y	Y		viewfinder parallax adjustment, bubble level.
Sputnik	Twin 2 $1/4$	\$300		75mm f/3.5	manual	$1/10 - 1/100, B$	Y	N	Y	N	N		Russian built, window in back of camera shows # exp taken. Reflex focus/view-finder. Uses 120 rollfilm
Stere-All	Realist	6,000		35mm f/3.5	fixed focus?	$1/50$ fixed, M	Y	Y	Y				
Stereo Duplex 120	"Realist"			25mm f/3.5		$1/5 - 1/100, B$	Y						upper/lower exp on 120 film, stereo/sin-gle
Stereo Graphic	Realist	15,000	\$180	35mm f/4	rangefinder	$1/50$ fixed, B	M,X		Y				
Stereo Meopta	View-Master			25mm f/3.5		$1/60$ fixed, B	M,X						Czechoslovakian made, 10' - inf focus
Stereo Mikroma	View-Master			25mm f/3.5		$1/5 - 1/100, B$	Y						Uses 16mm movie film, lenses focus slightly offset for improved DOF. Bubble level. Needs special Mikroma cutter.
Stereo Realist ST41	Realist	130,000	\$120	35mm f/3.5	rangefinder	$1s - 1/150, T, B$	Y				Y		
ST42	Realist		\$400	35mm f/2.8	rangefinder	$1s - 1/200, T, B$	Y					Y	
ST44	Realist		\$120	35mm f/3.5	rangefinder	$1/25 - 1/200, B$	Y	Y	Y	Y	Y	Y	
ST45	Realist		\$120	35mm f/3.5	manual		Y	Y	Y	Y	Y	Y	
TDC Stereo Colorist I	Realist		\$110	35mm f/3.5	manual	$1/10 - 1/200, B$	Y	Y	Y	Y			3' min focus
Stereo Colorist II	Realist		\$110	35mm f/3.5	rangefinder	$1/10 - 1/200, B$	Y	Y	Y	Y			
Stereo Vivid	Realist	20,000	\$180	35mm f/3.5	rangefinder	$1/10 - 1/100, B$	MF		Y	Y	Y	Y	$2 1/2'$ min focus, bubble level, continuously variable shutter speeds
Tower 83	Realist			f/3.5		$1s - 1/300, B$	M,F						3' min focus
Videon I	Realist	1,000											
II	Realist	1,000		f/3.5		$1/10 - 1/100, B$	Y				Y		

Table 2: Stereo Cameras no longer manufactured, available used

Model	Format	Estimated # ^a Manufactured	Approx. Cost	Lenses	Focusing	Shutter Speeds	Sync.Flash	Film Counter	Double Exp		Coupled film/shutter	Depth of Field Scale	Features
									Prevent	Capable			
View-Master Personal	View-Master		\$180	25mm f/3.5	fixed focus	$1/10 - 1/100$. B	M.F					Y	bubble level
Mark II	View-Master												
Windsor	Realist			35mm f/4.5		$1/25 - 1/50$. B	M					Y	Stereo or single frame
Wirgen	Realist	5,000		35mm f/3.5	manual	$1/25 - 1/200$. B	Y	Y	Y	-	Y		3' min focus
Wollensak Model 10	Realist	5,000		35mm f/2.7	rangefinder	$1/2 - 1/300$. B,T	MF X			Y			exposure meter, stereo or single frame
Wray				f/3.5		1/50 fixed							British-made Graflex clone. Lenses focused at slightly different points for improved DOF.

a. Estimates of number of cameras manufactured are generally made by surveys of serial numbers of cameras owned by collectors / club members. They are estimates only, and in some cases may be somewhat optimistic.

8.4 Other Techniques

8.4.1 Twin Camera

This technique uses two “identical” cameras mounted on a firm support (These are available from the suppliers, or you may build your own), and some means of synchronizing the shutters on the two cameras (see the section entitled *Shutter / Flash Synchronization*). Because of the lens-to-lens separation required, this method is not generally good for close-up photos.

8.4.2 Slide Bar

This technique involves using a purchased or constructed slide bar and a single camera to make both exposures. The author has used an aluminum plate with the edges folded to make a support against which the camera can rest, with a ruler glued to the back to determine the amount of image separation. The drawback to this technique is that the subject must be stationary between the two exposures. In spite of this, I have taken numerous successful landscape stereo pairs this way.

8.4.3 Beam Splitters¹

This system involves a system of mirrors or prisms which fit in front of the normal lens of an SLR, and “split” the film into a left and right version. A model using mirrors operates like this:

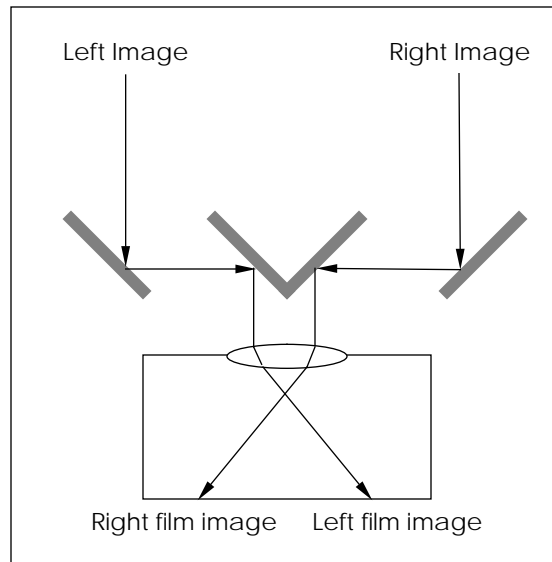

A similar arrangement is built into a viewer used to view either the slides or prints produced. (The images may also be free-viewed, cross-eyed method). Equipment currently available new using this principle includes the Ukrainian-made SFK-1 beamsplitter, the Franka beamsplitter, a 35mm attachment made by Pentax, and the Loreo camera.

1. Much of this material taken from an article by David Starkman in *Reel 3D News*, Volume 1, No. 3

9 Anaglyphs

Anaglyphs provide an alternative method to present two stereo views of an image to the left and right eye. This is done by encoding the views into a single image using different colors, and then viewing through complementary colored glasses (typically red/blue or red/green). The following excellent discussion of these techniques was provided:²

There are LOTS of ways to make anaglyph photos. In simplest terms: The basic idea is to use the principle of complementary colors to encode your stereo information. A stereo photograph requires a left eye view and a right eye view; to view a photo in stereo the left eye must see ONLY the left eye view and the right eye must see only the RIGHT eye view. Any combination of two complementary colors can achieve this.

In practice... You can produce an anaglyph stereo photo in camera one of the following methods:

1. By double exposing the film through complementary colored filters: click off one exposure through one filter for the first eye view, shift the camera over for the other point of view without advancing the film, change filters and expose for the other eye view. You must, of course, use color film.
2. You can take left and right stereo negatives and print them one at a time through complementary filters onto color positive paper to get an anaglyph photo in the darkroom. This works best with black and white negatives, but color negatives can be used, too, it's just a little trickier getting a pleasing color balance in the middle of the spectrum.
3. You could project left and right stereo positive slides (black and white is easiest, but color is not impossible) with complementary colored filters over the projection lens. The results tend to be muddy, but it does work with simple subjects.
4. Use a Polaroid camera with double exposure capability; use color film. Take the left eye exposure through one filter, re-cock the shutter, change filters, shift the camera and exposure the other eye view. Presto! An instant stereo anaglyph print.
5. Using a mirror box and beamsplitter rig, you can make anaglyph movies or stills by taping complementary colored gels over the left and right mirror openings. A company in England makes such a device for amateurs, who don't want to set up dual projection or who don't care to split the already tiny 8mm frame for left and right eye views.
6. Well, this could go on and on. Just apply the basic principle to whatever situation you are in and to what you have to work with.

FILTER CHOICE: Pretty broad range here, too. Many have already been suggested. Kodak's "Filters for Scientific and Technical Use" is the ideal reference with its very useful spectrophotometric graphs. Some people like to use the pair of Wratten #29 with #44; or you might try #24 with #60; maybe a 26 with 38A, or #25 with #55, etc. What you use depends upon the lighting (daylight or tungsten) and what kind of film you are using. You'll find yourself experimenting A LOT; so you may as well buy quite a few of the filters as gelatin squares from Kodak, and be prepared to play around.

Personally, I use a the #29 with a #44 to make anaglyph color slides. Basically, color slide film has red, green and blue sensitive layers (well that used to be the case, but now there are also lots of other layers added to improve color rendition) The red, green and blue layers are replaced with dyes that are cyan, magenta and yellow. Generally, if your filters achieve a good split between red on one side and green/blue on the other, the positive slide will have one eye view in cyan dye and the other eye view in magenta/yellow dye or red. If you juggle the amount of "crosstalk" between red and green, but stay away from blue, you can achieve a good yellow in the positive image, but this is really tricky.

2. Thanks to David Hutchison <71036.1477@compuserve.com>

10 Lenticular Photography

The makers of the Nimslo camera recommended the following be observed for the best effect in lenticular prints taken using that camera:

Camera to Subject Distance (feet)	Recommended Subject-to-Background Distance (feet)
6 feet	2.5
8	10
10	10
12	18
15	45
20	infinity

11 Slide Mounting / The Stereo Window

This topic is now covered by a separate document, "An Illustrated Guide to Stereo Slide Mounting", which should be available from the same place you acquired this document.

12 Projection

Basically, projection of 3D slides involves:

1. Use of a dual-lens projector, or two single-lens projectors
2. Polarized filters over each projection lens are aligned at right angles
3. Use an aluminum (silver) or lenticular screen, not a white one. A white screen will de-polarize the light projected, destroying the stereo effect. The silver or lenticular screens preserve the polarization of the projected light.
4. Polarized glasses are worn which match the alignment of the projector lens polarizing filters. In most projectors and glasses, the orientations of the polarization is in a "V" shape. A notable exception is the FED projector and glasses, which have the polarization in the vertical and horizontal directions.

13 Close-up Photography

13.1 Macro 3D Basics³

As a general rule, the smaller the object to be photographed in 3D, the more demanding the requirements of the equipment. The basic requirements are as follows:

1. A means of precisely controlling the elevation and angle of the two shots. Normally, you'll want the two shots to be exactly parallel. Compensation for the offset in the two photos is taken care of when you set the stereo window.
2. Precise control of the baseline. Initially, you may get by taking a batch of pictures and picking out the pair that gives the proper depth, but eventually you'll want to be a little more scientific about it. For objects one to several inches across, I like to control spacing to within about a millimeter.

3. Thanks to John Roberts

3. Control of the background, for when the object of interest does not take up the entire field of view. With focus at macro distances, distant objects will be badly out of focus. You may also want to allow more depth in your subject by eliminating infinity. I have some pieces of plain cloth of various colors, which I drape behind the subject. If the cloth is far enough back, it is entirely defocused, making a uniform background. If it's close to the subject, it still eliminates infinity.
4. Proper lighting is important. In macro stereo photography, it's usually desirable to get the depth of field as great as possible, so you will usually set the aperture very small. To get reasonable exposure times, you therefore need a bright light source. I haven't had much luck with incandescent lights - even halogens add a lot of red to the photo (this could probably be corrected by use of the proper filter). I've been using natural sunlight, which has its own problems during the winter or on windy days. If you use a flash, it is important that the flash unit not move relative to the subject between the two photos, because this would cause the shadows in the two images not to match. A fixed mount above or to the side of the camera (with connection to the camera with a flash cable) is ideal.
5. Proper exposure can be very tricky in macro photography. There are formulas that can be used, but it's easiest to use a camera that takes care of it automatically. I usually use a Minolta camera in autoexposure mode. This particular model (X-700) takes a final exposure reading *after* stopping down, so it can compensate for any inaccuracies in the stopping down process. It also uses TTL (through the lens) flash exposure control, so the duration of the flash is controlled by the illumination on what's in the field of view of the camera - *much* easier when you can do it. For best results, I suppose the distance from the object to the background should be relatively small compared to the distance to the flash. For special lighting situations, keep in mind that macro makes it even harder than usual.

For the first two requirements, a regular stereo "slide bar" can be used, especially if the magnification is not very great. Some people have built macro slide bars out of wood. I use a microwave tuning mechanism that I picked up at a hamfest. It has very precise gearing to control motion, and a millimeter scale with a vernier for 1/10 mm precision. They're pretty expensive new, but if you see one used, you ought to be able to get a good price.

13.2 Base Separation for twin-camera macro photography

The following table suggests the base separation between the two exposures for correct 3d macro photography:

Distance to Subject	Camera Separation
30"	2.0"
24"	1.6"
18"	1.2"
12"	0.8"
6"	0.4"

13.3 Convergence / Keystoning

Often someone new to 3D photography feels that, when taking a 3D pair, the camera should "toe-in" towards the subject. This misconception occurs in all 3D photography, but is most pronounced when taking a closeup (macro) shot. It is felt that the camera shots should point in, since that is what the human eye does.

The following article describes the keystoning error which occurs if this is done.

Keystoning/convergence error.

By Rick Wilson and John Bercovitz

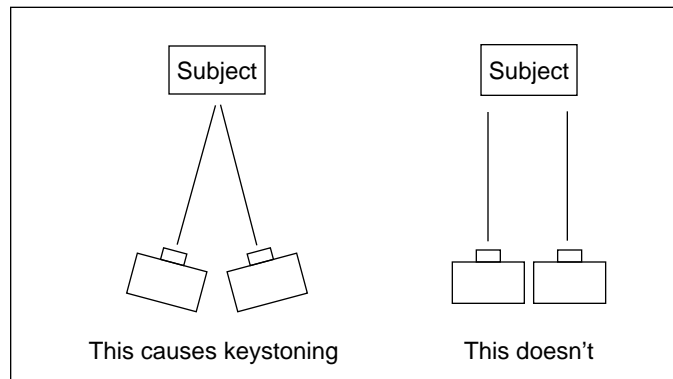

What is keystoneing (aka “convergence error”)?

Consider what an ideal camera is supposed to do. Take an ideal distortion-free camera. Mark a grid of evenly spaced lines on a wall and point the camera at the grid covered wall. Make sure the camera’s film plane is parallel to the wall. Take a picture. Look at the picture and it has a grid on it too. It is a “scale drawing” of the grid on the wall. You can lay a ruler on the picture and you will find all the lines are straight. You can use that ruler to measure all the squares in the grid and you’ll find they’re all the same size.

Now tilt the camera’s film plane so it’s no longer parallel to the grid-covered wall. Take another picture. This time the lines in the picture are still straight* but the squares are no longer all the same size. Also, the squares have become trapezoids or other sorts of quadrangles. These shapes are called “keystones”. If you take two pictures as shown in the left illustration, you will get keystoneing. The left camera will make a picture with the small ends of the keystones on the right, while the right camera will have make a picture with the small ends of the keystones on the left, like this:

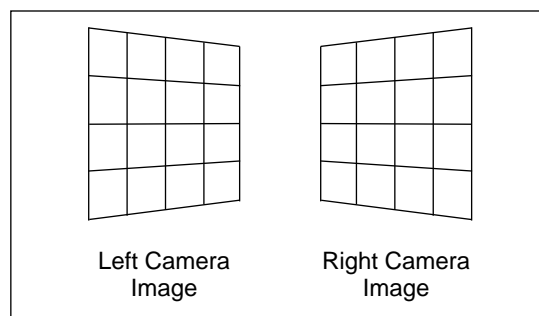

When you go to merge those two pictures in a viewer, you’re going to have trouble. The flat wall becomes warped. If the keystoneing is severe the pictures will be painful to view if they can be merged at all.

As with a lot of these things, you can get tangled up. The first thing you’re going to think is that the left illustration shows how your eyes see things. That’s right. But remember your eyes are being presented with an evenly gridded wall in real life so they ought to be presented with the same thing in the viewer.

*I’m simplifying slightly here.

14 Photomicrography

15 Aerial Photography

The following was contributed by Bruce Gold:

Point camera perpendicular to direction of flight. During cruise, assume craft points where it's going. Not so during maneuvers: take-off and landing are nose-high. Also not turns, aerobatic maneuvers. Probably not a problem. Just keep it simple.

Light aircraft usually cruise at 100-150 f/s 30-50 m/s. Guess the distance to your subject and figure the interocular basis you want; 1/20 to 1/50 of the subject's distance. Then decide the number of seconds between pictures. Try taking a quicker triple instead of a slow pair of pictures to give yourself more options later. Direct sunlight on aircraft window causes gross flare and reduction of contrast. Camera gets shady side of craft. A polarizing filter helps contrast, too. Forget long lenses; too much vibration.

Example1: Mountain is 2 miles or 10,000 feet away. <--Remember you're guessing. You are travelling 100 f/s. $10,000/50 = 200$. $10,000/20 = 500$. $200/100 = 2$ seconds. $500/100 = 5$ seconds. A pair should be exposed around 2-5 seconds apart.

Example2: Forest nymph is 500 meters away. You are travelling 50 m/s. $\text{dist}/\text{ratio} = 500/50 = 10$ m interocular distance or $500/25 = 20\text{m}$. i.o. $\text{dist}/V = 10/50 = .2$ second or $20/50 = \text{nearly } 1/2$ s. (Remember the precision of the original data before condemning this coarse arithmetic.) Image pair should be < 1/2 second apart. You are too close. You probably can't take them that fast. She might throw a rock and knock you out of the sky. (Nymphs're tough!) And you might crash because your pilot is obviously looking at the nymph instead of where you're both going.

Clean the windows thoroughly, inside and out. Bring along cleaning towels anyway.

Barry Levin adds:

The quick answer is use the one-in-thirty rule: $6000/30 = 200$ foot separation. 100 mph is $146 \frac{2}{3}$ fps. $200 \text{ ft}/146 \frac{2}{3} \text{ fps} = 1.36$ seconds delay. So your shots with the longer delays may be difficult to fuse. The answer above is correct if you were pointing the camera straight down. If you were pointing it out an an angle of, say, 30 degrees from the vertical, then you would divide the 1.36 seconds by the cosine of 30 degrees to get 1.57 seconds; not enough difference to worry about. By the same reasoning, if you were 60 degrees off the vertical, then the time delay would be doubled.

John Roberts adds:

Those angles should apply to the *bottom* of the field of view, rather than the center. (Watch out for clouds - if they're the closest objects, they should be the reference for calculations.) I would also recommend trying a range of interocular/distance to subject ratios of 1/30 to 1/50-70 (or even 1/100). I seem to get the best results for hyperstereo using a ratio of 1/50 to 1/70 (using an SLR camera with a 50mm lens). If you can afford the film and processing, it doesn't hurt to hedge your bets by taking a series of photos, so you can pick out good stereo pairs later - after all, airplane tickets are pretty expensive compared to the cost of film. I sometimes take three or four pictures as rapidly as I can advance the film (with an autowinder, I'd be a little more scientific). If you find your stereo pair has too much depth, you can often salvage it by cutting off the bottom of the photo, which in a photo from an airplane has the closest objects.

Another very rough rule of thumb I sometimes use when I don't have other criteria for judgement: the second shot should be taken when the view shows a barely perceptible difference from that of the first shot. It helps to remember this rule of thumb even when you calculate the spacing more precisely, since it's intuitive and helps in avoiding order-of-magnitude errors.

16 Astrophotography

16.1 The Moon

In a book somewhere I saw a stereo pair of the full moon. The moon wobbles slowly on its apparent axis from side to side (nutation, I think this is called) So somebody took 2 separate full moon shots one when the moon was twisted left and one twisted right. The text explained that the effective separation of the two eyes viewing it would

be over a hundred miles, a giant's eye view! It was most effective. So, if you have moon shots taken on different occasions, try pairing them up!⁴

16.2 Astronomy 3D Articles

Source	Contents
<i>Sky and Telescope</i> , April 1988 "The Sky in Stereo"	Reproduces stereo pairs of the full moon, a total lunar eclipse giving the effect reported in a recent e-mail, an artificially created pair showing what the Big Dipper stars would look like if seen with a huge interocular separation, and the moon's surface taken by Cernan and Schmitt. It mentions a 1909 paper describing stereo views of Comet Morehouse. The full moon stereo view is circa 1864, and they say that other planets, comets, eclipses, asteroids and the 1874 transit of Venus were also photographed and published as stereo views.
Stereo World	Vol 15 #3 - Pairs of the moon, scenes on the moon. The sun, mercury, a meteor, Mars, and Phobos. Vol 16 #3 - The Apollo Mission. Vol ?? #? - Stereo photo of a meteor.

16.3 Other Astrophotography topics

Although not actually 3D, an interesting application is being used by an acquaintance of mine - he takes two photos of the same section of night sky a couple of hours apart. When viewed with a 3D viewer, he looks for anything which does not "match up" between the two photos. He is using this to search for comets.

17 HyperStereo⁵

Hyperstereo refers to using a larger than normal base, or separation between the lenses taking the left and right images. Usually this is obtained by using either two cameras widely separated, or by separate shots made by the same camera tens or even hundreds of feet apart. This can give a stereo effect to distant objects which would not normally display much.

When shooting a hyperstereo pair, you should bear the following in mind:

1. As a *guideline*, use a separation of approximately $1/50$ of the distance to your main subject.
2. Try to take both photos from the same "level" - avoid vertical changes between photos.
3. Unlike normal stereo, avoid foreground objects as much as possible - they can be very distracting
4. You will need some method to synchronize the framing of the two images. Use registration marks in the viewfinder, distant objects at the edge or center of the frame, etc. to adjust both images within the viewfinder.
5. You may find it useful to switch to manual exposure to make sure both exposures are the same.
6. David suggests this for mountain scenes, city scenes taken from opposite sides of a tall building.

18 Shutter / Flash Synchronization⁶

4. Thanks to David Carter (dactyl@netcom.com)

5. *Hyperstereo* by David Starkman, *Reel 3D News*, Volume 1, No. 6.

6. Much of this paraphrased from Alexander Klein, <100041.212@COMPUSERVE.COM>, and John Bercovitz.

This topic applies to twin-camera setups, and refers to the difficulty of synchronizing the shutter mechanisms of two separate cameras. This is especially critical when using flash, due to the extremely short duration of typical flash units. Shutters on both cameras must be completely open when the flash occurs. Methods of addressing this include:

Table 3: Shutter Synchronization Methods

Method	Advantages	Disadvantages	Comments
Dual Cable Release	Inexpensive	Poor synchronization	The button must be pushed quickly to get reasonable sync (some hit the button). Sync may not be good enough to use flash
Spring-loaded			
Air-pressure	Good for SLRs up to several feet apart		
Solenoids	Most accurate of mechanical solutions		Suggest use of a storage scope for adjustment
Electrical	Good synchronization		For cameras with electrically-activated shutter

For flash synchronization, the following method has been tried with a camera with electric cable release (specifically the Minolta X-700)⁷

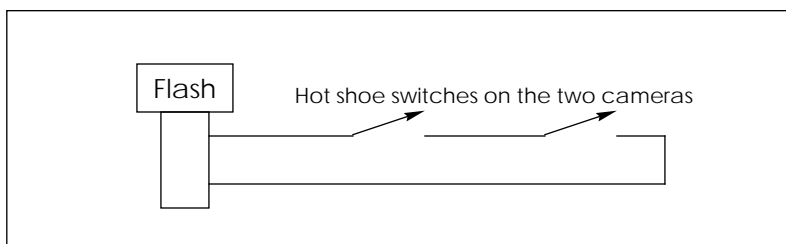

This has the effect of ANDing the two camera hot shoe switches, causing the flash to not fire until both shutters are closed. Kevin cautions: "It was a little tricky getting the wires right, and I got zapped a few times because I forgot that the outer connections of cameras' pc-jacks are already connected via the bodies and aluminum plate they're mounted on".

19 Special Effects

19.1 Time Exposures

A recent discussion on the 3D mailing list suggested that interesting stereo effects can be had by "painting with light", using a long time exposure in a dark setting, while a person moves a sparkler, flashlight, or other light source in a 3D pattern in front of the camera. If desired, a flash may be fired sometime during the exposure to freeze a picture of the person doing the movement. The light trails will come out in 3D.

*** Anyone care to recommend a starting point for the exposure?

19.2 Stop Action Photography using an audio flash trigger

7. Credits to Dave Horn, John Bercovitz, and Kevin Skelton

This method uses some type of audio input to control when the camera flash fires, and can be used to take 3D photos of things like water balloons breaking, etc. Several suggested methods are presented here, so hopefully you can find one which matches your level of hacking expertise!

19.2.1 Sound Trigger II

This circuit and its accompanying directions and hints was originally posted on the InterNet newsgroup "rec.photo" by Alan Killian.

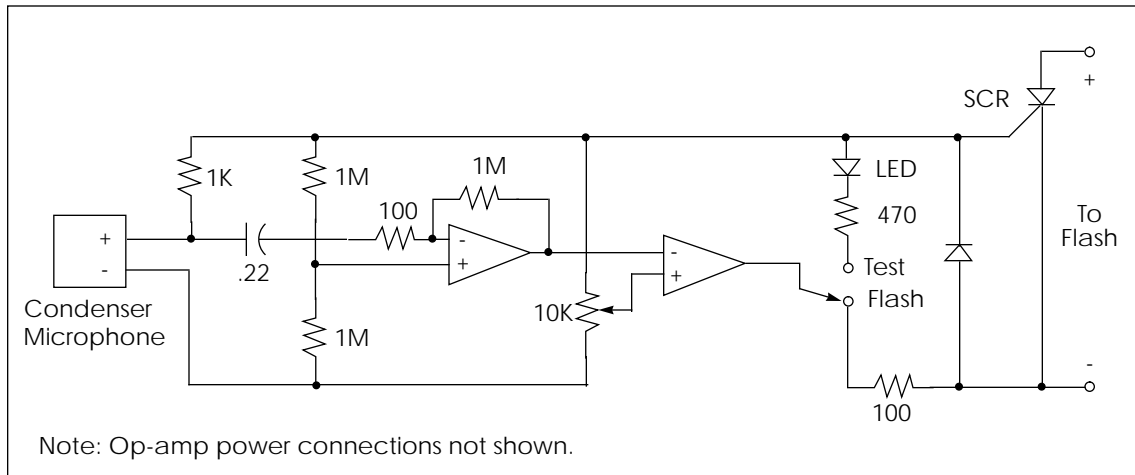

NOTE - JKA - check op-amp pos/neg connections vs. data sheet!

This is a circuit to trigger a flash unit when something makes a noise.

1. You setup your camera pointing at something. (Like a light bulb)
2. Aim the microphone at the something. (The light bulb)
3. Turn off the lights so that it is dark in the room.
4. Do not fondle your neighbor.
5. Open the shutter of your camera. Use the 'B' setting and a locking shutter cable release.
6. Turn on your flash. Remember to be quiet or else you will trigger the flash. This is why we have the 'no fondling' rule.
7. Hit the something with something less fragile. (Hammer on light bulb)
8. This will cause the flash to flash and you will get a great photo of flying light bulb parts.
9. Do not hit the camera or any body parts. Remember it's dark in here.

Tips:

1. Put a sheet of glass right in front of the camera to protect it from flying things. You may need to make a tube that goes from the front of the lens to the back of the glass and paint it black inside to reduce glare from the flash.
2. Break things inside an empty fish tank to keep parts from flying too far.
3. Move the microphone farther from the sound source to vary the time from breaking to picture taking. The farther the microphone is from the event, the farther the parts fly before you grab them.
4. It's impossible to aim anything in the dark so try setting a rock up in a guide before you turn out the lights and then removing the catch in the dark.

5. Put a mirror on the far side of your object to reflect the flash back onto the object. This improves the lighting and prevents black shadows.

The trigger has a 'test' switch which lights up an LED every time the flash would trigger. Set the trigger on test and clap or snap your fingers to get the sensitivity just right. Then switch to flash. Switching to flash MAY trigger your flash so do this with the lens covered or the flash turned off.

Opening the shutter almost always triggers the flash (Unless you have set the sensitivity to detect bowling balls falling on porcelain clowns) so turn off the flash before opening the shutter and then turn it on before doing the deed.

Close the shutter fast after the deed so that you do not trigger the flash more than once. (You WILL do this. I guarantee it or your money back)

How to compute exposure:

For a manual flash you need to know the 'Guide number' It's something like 38 or 45 or 278 (For those who spend REAL money on flashes) Take the guide number and divide by your f-stop to get the number of feet between your flash and the object (Not the flash to camera distance)

So for a guide number 38 flash at f8 you get $38/8 = 5$ Feet.

Guide numbers lie. They are designed for normal photos where some light bounces around the room and lights up your subject. If you are doing this right everything but your objects will be painted flat black and they won't reflect any light so the guide number you get off your flash is too large. I reduce mine by 30% so a 38 guide number becomes 27 and in our previous example I would put it $27/8 = 3$ feet away.

Don't get a big hubristic flash and expect to get good photos. The bigger the flash the longer it emits light (Generally) and the more the flying things will blur. You want a tiny flash a half foot from your subject to get good stopping power.

For an automatic exposure flash:

There are two ways to do this. First set it on auto and set the distance from your flash to subject and read the f-number off the back of the flash. This will probably be too small an f-number to get much depth-of-field but it will work. The second way is to set the flash on auto and read the f-number and then decide what f-number you want to use and put that much filter over the flash's sensor. Not over the strobe tube but over the light sensing element. For example: The flash say's f2 and you want f8. That's 2.8,4.0,5.6,8.0 = 4 stops less exposure so put a 4 stop filter over the sensor and it will emit 4 stops more light out before it extinguishes the strobe. You will also get more motion blur but less blur due to lack of depth-of-field.

For those of us with too much money:

Plug your flash into your Minolta spot meter and point it at a grey card and flash. The meter tells you the f-number. Keep piling more filters in front of the flash's sensor until the meter say's the f-number you have the camera set onto. I set the exposure time at 1 second on the meter for this although it doesn't seem to matter much as the room is dark after all.

If you have reversed your lens remember that the f-number on the lens is wrong. Add 1 or 2 stops of exposure to correct for this. This means pretending the lens is set of f16 if it's really set on f8. Also remember to rig up something to get the aperture closed down if your lens doesn't automatically do that when you take it off the camera.

Things to take photos of:

1. Things falling into a fish tank. Set your camera looking into the side of a fish tank. Fish are optional and drop things into the top. Coins, Madonna cassette tapes, watches, light bulbs (If you haven't broken them all)
2. Things falling onto other things and one of the two things breaking.
3. Milk drops (Very cool)
4. Balloons breaking. Water balloons are very cool. Water balloons filled with windshield washer fluid are cool in color.
5. Pencils breaking, Glasses breaking, Arts breaking.
6. A knife cutting an egg.
7. Bullets going through things. (Your strobe is never going to be fast enough to get good pictures of this though) Do not shoot your neighbor through the dark room wall. Although shooting your neighbor INTO the dark room wall would make a nice splatty photo.

Things about the circuit:

Nothing is critical. Use different opamps if you like. The LM324 has 4 amplifiers and you might be able to use two of those instead of a LM741 The Microphone was a condenser microphone from radio shack. It was just an element, not a whole microphone.

The 'medium diode' is just for surge protection and I'm not sure it really does anything.

Some flashes have 6 volts across the terminals and some have 400 Volts. This works with both. Make sure you get a 400 Volt SCR if you have a 400 volt flash. If you have a 6 Volt flash a 200 Volt SCR will work until you loan this circuit to someone else.

19.2.2 Simple Sound Trigger

Andrew Davidhazy suggests this simple alternative for those not inclined towards electronic circuit assembly:

The basic concept was mentioned way back in the age of tube technology and was again rediscovered in the transistor age.

Start with a readily available amplifier. Today it might be a discarded cassette tape recorder. The old fashioned kind that did not have ALC, (auto level control) is best. Then it will have manually adjustable record level and a VU meter is typically built in.

Cut an earphone cord that would connect to the earphone jack of the recorder and connect one of the two wires that come from the plug that connects into the earphone jack to the Cathode end of a 400 volt SCR, and the other wire connect to the Gate end.

Connect the Anode end to one input to the flash sync cord and the Cathode to the other. Flashes are typically polarized so you will have to connect SCR in proper orientation but usually all you need to do is to reverse the A and C connections and the system usually works.

Place a cassette into the recorder (or fool it into going into record mode without a cassette in place). Plug above cord into it's proper EARPHONE jack.

If you started at low volume setting then raise volume. Eventually the flash should fire. Lower the volume setting below this point. Now making a noise in front of the microphone should cause the flash to fire.

Principle is that as recorder hears sound voltage level going to earphone goes up. Once it is high enough the SCR triggers and then the flash triggers too!

The SCR should cost about \$1.50 at Radio Shack. The recorder maybe \$10 at a garage sale or a flea market. This was suggested about 2 years ago by James Bailey who writes now for Pop Photo. But I've also seen it in the PSA Journal maybe 15 years ago. We have been building such devices with great success here for years. If you use ALC recorder the device is simply harder to use because it becomes so sensitive.

19.2.3 Other audio strobe possibilities

You may also wish to consider the following sources:

"Super Strobe Trigger", Radio Electronics, November 1992

"Freeze Frame", available in kit form from PAiA Electronics, Inc., 3200 Teakwood Lane, Edmond, OK, 73013, USA. Phone: (405)340-6300 FAX: (405)340-6378. Contains sensors for either sound or infra-red, so anything which makes a noise, flashes, or blocks light may be captured. This is not an endorsement of this product, simply letting you know that it exists... Apparently there was an article on this in "Electronics Now", November, 1992.

20 3D Video

20.1 Alternate-frame Video

20.2 Anaglyph Video

Anaglyph video uses the same principle as anaglyph still photography: Separation of the two views by use of two color filters.

20.3 The Pulfrich Effect

Contributed by:

It sounds alot fancier than it really is: Get a buddy to drive a car about 10 MPH along a suburban neighborhood where you have things (trees, fences, houses, etc.) both near the road and far away from the road. Your job is to sit in the front passenger seat, hold the recording video camera steady, and just point it out the right window, perpendicular to the direction of travel. Then rush back home and watch the video with only the right eye covered by sunglasses (I used polarized flip-down shades, but polarization has nothing to do with it) and you have Pulfritch 3d !

I saw my first homemade Pulfritch at the 1989 NSA Convention in Portland, OR, which was taken out the side of a Disneyland monorail.

The reason: Things closer to the camera will move faster across the TV screen. The dark lens on the right eye reduces the scene's light intensity to the right eye. The brain takes longer to process dark scenes. So, by the time the brain has processed the fast moving tree in right eye's scene, the left eye's tree has already moved farther to the right. To focus the tree the eyes must cross more, thereby giving the illusion of a closer tree.

So, with the dark lens on the right eye, things that move faster to the right appear closer, and things that move faster to the left appear farther away.

Prove it: Hang a specular reflector (like a metal spoon) in the center of a doorway with a string. Swing the spoon side to side like a pendulum (always same distance to you). With the dark lens on your right eye, the spoon will appear to swing in a circle: closer to you when moving to the right, and farther from you when moving to the left (counterclockwise from above). Move the single dark lens to your left eye and the spoon will now appear to swing clockwise from above.

Mike Watters adds:

Rotation (ie having the CAMERA spin around) doesn't work. If you think about it briefly, you'll see that the camera's orientation never changes in relation to the subject(s) so their isn't any source of stereo information. However having the SUBJECT spin around, like the Ukranian skater (you'll have to forgive me for not trying to spell her name) in the olympics, the bed in the "magic bed" video or in the goldilocks and the 3(-D) Bears video, works fairly well.

The foreground (moving from left to right) will appear to be in front of the screen and the background (moving right to left) will appear to be behind the screen.

Moving the camera sideways (ie stick it out the side window of your car as you drive) also works well. In this case everything is moving left to right (if you stick the camera out of the right-hand window) and will appear to be in front of the screen. Since closer objects will move across the screen faster, they will be more "in front".

For a handy-dandy preview, put on your pulfritch glasses next time you are in the car (hopefully as a passenger) and look out the window as you move along. The world will look like it's in hyper-stereo. I can't recall who on the list originally posted about this last suggestion, but I tried it and it works great. I guess what I SHOULD have tried was putting the glasses on backwards and having a peek at "pseudo-world". :)

Oh, one final note: Since the effect works off motion (I think the dark filter must be having some sort of effect on persistence of vision, in terms of a mechanism) only objects that are in motion on the screen will show any stereo. Thus; the skater will appear fully 3D when shoe spins (with a flat background), while as she skates sideways both she and the background will be flat but seperated from each other (the infamous cardboard-cutout effect).

20.4 IMAX 3D

Andrew Woods provided these locations of IMAX theatres which are set up for 3D projection:

IMAX-3D: *

- CN IMAX theatre, Vancouver, British Columbia, Canada
- Sapporo Beer Factory, IMAX-3D theatre, Sapporo, Japan
- Great America Theme Park, Lockheed Pictorium, Santa Clara, California
- Six Flags Great America Theme Park, Pictorium, Gurnee, Illinois
- Moody Gardens, IMAX 3D theatre, Galveston, Texas
- EXPO'93 City Pavilion, IMAX 3D theatre, Taejon, South Korea

SOLIDO: (OMNIMAX-3D)

- Futuroscope, IMAX SOLIDO theatre, Poitiers, France
- Japan (somewhere south of Tokyo...)
- and soon IMAX-3D at the Lincoln Centre in New York.

The projector for this theatre is one of the new double decker rolling loop projectors which accept two reels of 70mm film (one left film path and one right). It can also do IMAX-HD (48fps). The reels for this projector are also designed to take two hours of film at IMAX-HD rates. They're pretty huge! It's the first IMAX projector to do both 3D and HD.

21 Stereo Clubs / Associations / Periodicals

Table 4: Stereo Clubs / Associations / Periodicals

Name	Address	Publication
3- Magazin	3D-Magazin Bode Verlag Durenberg 2 D-45716 Haltern, Germany	3D-Magazin, published quarterly in the German language
International Stereoscopic Union	ISU P.O. Box 19-119 Hamilton, New Zealand <100041.212@CompuServe.COM>	Stereoscopy (published quarterly)
National Stereoscopic Association	P.O. Box 14811 Columbus, Ohio 43214	Stereo World
Stereo Club of Southern California	????	3-D News
View-Master / Tru-View Collectors Association	V.T.C.A Box 47891 Minneapolis, MN 55447 USA	ReView (newsletter)
See also: "3D Clubs" list maintained by Tim Klein (Refer to Appendix B - "Information available via anonymous ftp")		

Appendix A: Film Image Format

This appendix gives the placement on film of several 3D formats. These appear actual size in the original print of this FAQ. The same length of film is shown in all cases for comparison purposes, even though this does not always allow an even number of frames to be shown (i.e. the Realist and European formats)

A.1 Standard 35mm film dimensions

For complete information, refer to **ANSI standard PH1.14-1990**.

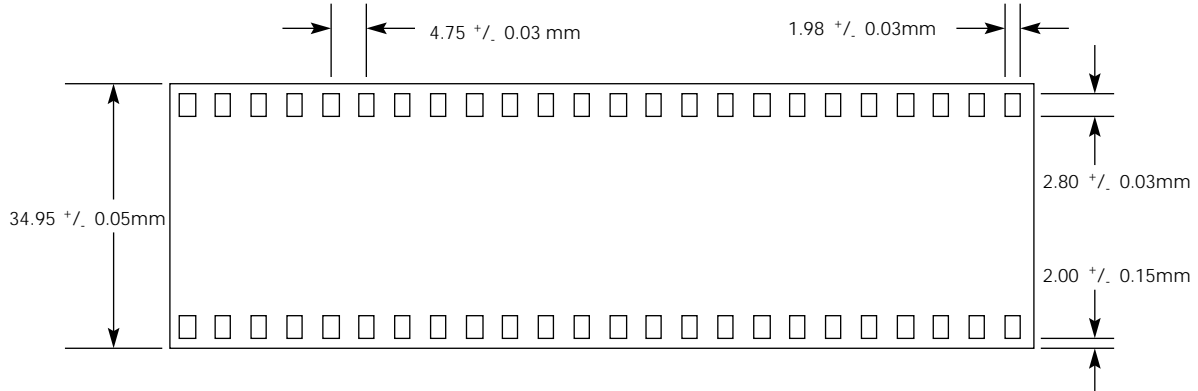

A.2 View-Master

A.3 Nimslo / Nishika (4 lenses) - 4 sprocket (24 x 18)

Film chip size is nominally 18 mm with a 1 mm frame separation.

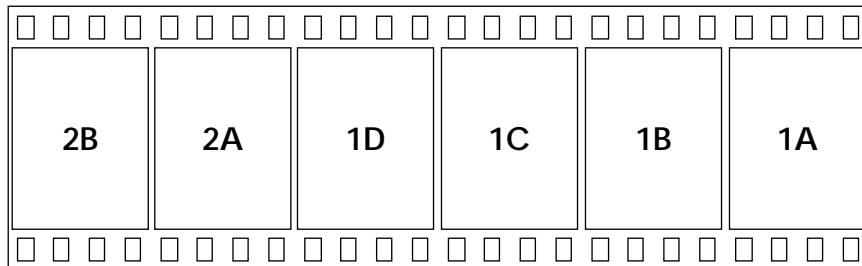

A.4 Image Tech 3d Magic and 3d Wizard (3 lenses) - 4 sprocket (28 x 18)

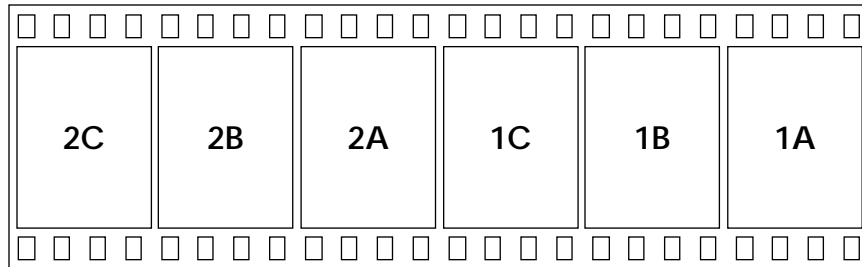

A.5 Image Tech Professional (5 lenses) - ???

A.6 Realist - 5 sprocket (24 x 23)

Film chip size is nominally 23 mm wide with a 0.75 mm frame separation

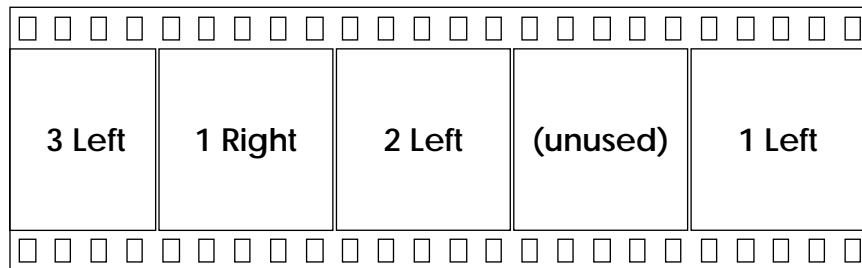

In this format, the film advances two frames for each exposure. This results in an unused exposure at the beginning and end of the film. The extended film sequence is 1L-unused-2L-1R-3L-2R-4L-3R- etc.

A.7 European - 7 sprocket (24 x 30)

The film chip size is nominally ?? mm, with a ?? mm frame separation.

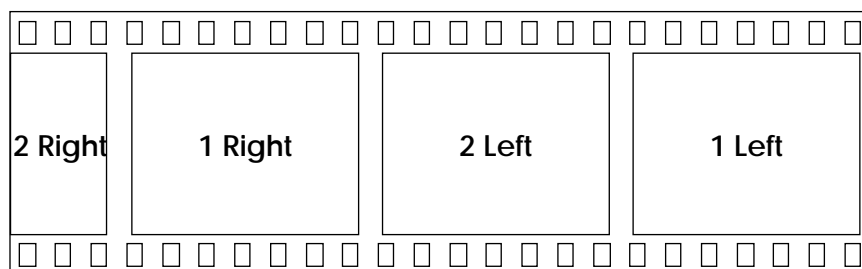

This pattern requires the camera to advance first one frame, then three frames - the extended sequence on film is 1L2L1R2R - 3L4L3R4R - 5L6L5R6R - etc.

A.8 Half-Frame - side-by-side on 8 sprocket ($1/2$ of 24 x 36)

The film chip size is 36.?? mm wide, with a ?? mm frame separation.

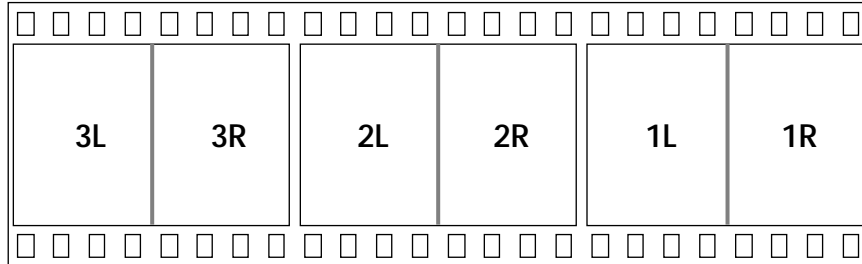

A.9 Standard 35mm - 8 sprocket (24 x 36)

The film chip size is 36.?? mm wide, with a ?? mm frame separation.

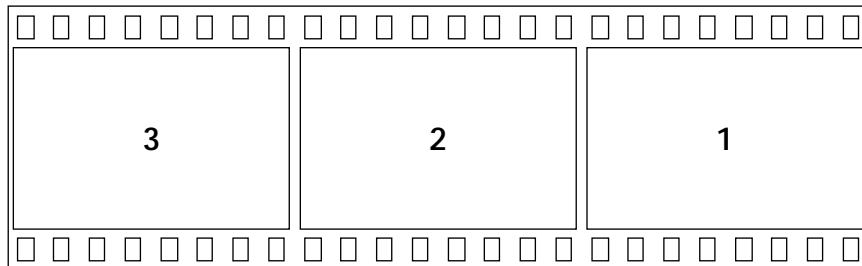

Appendix B: Information available via anonymous ftp

The following sites supporting anonymous ftp access contain information about 3D photography or photography in general:

Table 5: Anonymous ftp sites containing 3D/photography information:

ftp site	directory	contents
hipp.etsu.edu (192.43.199.82)	/pub/photo	3D FAQ, 3D images
moink.nmsu.edu (128.123.4.58)	/rec.photo	FAQ files from the rec.photo newsgroup, including information on general photography, filters, dof equations, survey of mail order houses (good!) lens test charts, Canon and Nikon info, photo/darkroom experiments, zone system summary, other info. Nothing 3D (yet!) but a good source of general photographic info.
morgan.ucsf.edu (134.153.2.99)	/pub/stereo	Stereo GIF files (for cross-eyed free viewing)
pit-manager.mit.edu (18.172.1.27)	/pub/usenet/rec.photo	A copy of some of the info on moink.nmsu.edu, specifically the rec.photo FAQ, a Nikon FAQ, and info about a medium format email list.
sunsite.unc.edu (152.2.22.81)	/pub/academic/ computer-science/ virtual-reality/3d/ stereo_pairs/ photo,fractals,earth stereograms red_blue	A large selection of stereo GIF files
explorer.arc.nasa.gov (128.102.32.18)		Space-related GIF files - images from Mariner, Voyager, Magellen, Galileo, Pioneer, Shuttle, and Ulysses missions. The ames system has a very organized data base of stuff including raw gif images in red, green, and blue, so you can combine stuff together yourself.
ames.arc.nasa.gov (128.102.18.3)	/pub/SPACE/GIF/3d.GIF	
seeds.lpl.arizona.edu	pub/spacecraft/ CLEMENTINE/images	For images from Clementine spacecraft

Appendix C: User's comments on stereo cameras

In this section, no attempt has been made to attribute specific comments to individuals, due to the large number of comments presented. Keep in mind that these are user's opinions - there are likely to be some contradictions, and they're worth what you paid for them!

Table 6: User comments - stereo cameras

Camera	Comments
Belplasca	"Allegedly the sharpest lenses of any stereo camera"
FED	"Reasonably well constructed. Weak areas: 1. There is a small part inside the camera that can bend up and allow the shutter to stick open. 2. If you are playing with the camera without film in it, it will jam when the film counter goes past 18. It is easily fixed, but you need to take the top off. 3. You can only use the little plastic lens hoods in the bulb and flash modes - otherwise they block the light meter. 4. The normal and stereo mounts are terrible"
Iloca I	"On some models all controls were not synchronized, so you had to set f-stops on each lens separately"
Image Tech	
3D Magic	"Handling is very simple." "Should be able to reload with reasonable care."
3D Wizard	"Quite acceptable quality, especially considering the cost" "Optical quality is MUCH better than the 3D Magic"
Kodak	"Especially vulnerable to dust in the shutter and wear of an element of the film wind mechanism."
Nishika	"Cheap Cheap Cheap. Fuzzy lenses."
Revere Stereo 33	"Beautiful piece of work. Arguably the prettiest of more common American, if not all, stereo cameras. Beautifully finished brushed castings. Heavy, though. Would make a good weapon in a pinch." "Only thing missing is a self timer and thumb lever film advance"
Stereo Realist	"Nasty vignetting problem" "I HATE the film rewind"

Appendix D: Quotable Quotes

"Get some of those 3D glasses and put them on. Get enough pairs to make it up to, say, 10 or 12 D."
 Comedian Steven Wright

"A man can give a very close friend advice about the choice of a wife, or cigarettes - but, if he values that friendship, will never offer advice about the choice of an auto, or a camera."
 Herbert C. McKay, on the choice of format for 3D photography.

Appendix E: Depth of Field Charts

E.1 Interocular Separation for Close-up Photography¹

From "Stereo Realist Manual" by W. D. Morgan and H. M Lester about 1954, p. 285:

Table 7: Interocular Separation for Close-up Photography

Lens-to-Subject Distance	Total Lens Separation	Scale Pos. for Pointer A	Scale Pos. for Pointer B	Diopter Lens
30"	2.0"	-1.0"	+1.0"	1
27"	1.8"	-0.9"	+0.9"	1
24"	1.6"	-0.8"	+0.8"	1
21"	1.4"	-0.7"	+0.7"	1
18"	1.2"	-0.6"	+0.6"	2
15"	1.0"	-0.5"	+0.5"	2
12"	0.8"	-0.4"	+0.4"	3
9"	0.6"	-0.3"	+0.3"	4
6"	0.4"	-0.2"	+0.2"	5

Pointer "A" is directly behind middle of left lens. Pointer "B" is directly behind middle of right lens. "0.0" is half-way between them. Use Series V Portra Lenses: +1, +2, or +3, singly or in combination. You need a cap which fits tightly over one lens at a time for the double exposure that you will take.

E.2 Linhoff Universal Depth of Field Chart

Note: The original chart had entries up to f/250 - I have shortened it to a more useful range.

Table 8: Linhoff Universal Depth of Field Table

Film Format				f/stop
5.6 x 7.2 cm 2 1/4 x 2 3/4 in	9 x 12 cm 4 x 5 in	13 x 18 cm 5 x 7 in	18 x 24 cm 8 x 10 in	
1.2	1.6	2.4	3.2	8
1.7	2.2	3.3	4.4	11
2.4	3.2	4.8	6.4	16
3.3	4.4	6.7	9.0	22
4.8	6.4	9.6	12.8	32
6.7	9.0	13.5	18.0	45
9.6	12.8	19.2	25.6	64

1. Contributed by Doug Eernisse

Directions for use: Focus camera to far and near object points and measure bellows extension difference in mm. Look up this figure in the appropriate format column above. Read off the f-stop required to obtain the necessary depth of field in the same row, right column. Set the rear standard at half the displacement.

In close-up work the values shown in the table should be corrected as follows:

Table 9: Close-up correction factors

Distance from diaphragm to a point 1/3 into the depth of field (f = focal length)	Open up an additional:
6f	$\frac{1}{2}$ stop
4f	$\frac{2}{3}$ stop
3f	1 stop
2r	2 stops
1.5f	3 stops
1.3f	4 stops

Appendix F: Archives of articles in the 3-D mailing list²

Archives of articles for the current 3D mailing list may be obtained from the ftp site bobcat.etsu.edu, in the photo-3d directory. The archive files have a six-digit date in the file name. Each file contains all articles between the date in the file name, and the next-most-recent file present.

2. Thanks to Chris Sherman for the info and Kevin Skelton for telling me about it!

Appendix G: 3d email list camera measurements

The following are measurements taken on cameras owned by or available to subscribers of the 3D mailing list, for informational purposes and in computing the stereo window. Due to different measurement methods used, measurement tolerances vary.

Table 10: Measurements on selected stereo cameras - Realist format

Camera	Serial Number	Measured Lens Separation (mm)	Measured Gate-to-gate (mm)	Measured Gate Width (mm)	Measured Gate Height (mm)	Listed Focal Len. (mm)	Calc. Nominal Window (m)	Measurement Tolerance
Edixa I	n/a	69.81	71.34	21.75	23.75	35	1.63	+/- 0.03 mm
Kodak Stereo	039923	70.23	71.12	22.76	25.15	35	2.80	+/- 0.1 mm
Realist 3.5	A78438	69.95	70.90	23.45	25.35	35	2.61	+/- 0.03 mm
	n/a	69.5	70.5	23		35		+/- 0.5 mm
	A86421	70	71	23		35		+/- 0.5 mm
	A11873	70	70.5	24		35		+/- 0.5mm
Realist 2.8	A57472	70.07	70.95	23.55	25.35	35	2.82	+/- 0.03 mm
	A71889	70	71	23.5		35		+/- 0.5 mm
Revere 3.5	V-20029	69.85	71.01	23.00	25.00	35	2.14	+/- 0.03 mm
Stereo Graphic	1002597	69.92	71.13	23.00	25.41	35	2.06	

Table 11: Measurements on selected stereo cameras - European format

Camera	Serial Number	Measured Lens Separation (mm)	Measured Gate-to-gate (mm)	Measured Gate Width (mm)	Measured Gate Height (mm)	Listed Focal Len. (mm)	Calc. Nominal Window (m)	Measurement Tolerance
Belplasca	07664	63.50	64.10	28.95	24.05	37.5	4.00	+/- 0.03 mm
FED	204366	63.44	64.34	29.33	23.58	38	2.72	?
Sputnik	045107	63.48	64.17	55.18	55.21	75	6.98	?
VerascopeF40	3370091	63.41	63.70	30.00	24.20	40	8.78	+/- 0.03 mm

Appendix H: Camera Repairs / Maintenance / Modifications

Note: The following procedures have been presented by the members of the 3D mailing list. No guarantee is made as to the accuracy or suitability of these procedures to a repair you are contemplating. These repairs vary in difficulty - assess your skill levels before tearing into your camera!

H.1 Kodak Stereo Camera

H.1.1 Procedure: Removing the top of the camera

Thanks to: Mike Watters

The two control knobs screw off (normal thread). Just secure the part inside the camera so it won't turn (i.e. stick a screwdriver in it) and unscrew the screws on top of the knobs. When these are removed, a couple screws will be revealed (one near the edge of each end under where the knobs were). These screws are what hold the top on. Unscrew them and the top comes off. You'll want to keep an eye on a few little parts which will probably fall out (viewfinder lens and cover).

Getting the top back ON:

Pretty much the reverse of the above. The only tricky part is getting the frame counter in position. The problem is pretty obvious when you look at it. It's also pretty simple to jiggle it into position to get the top on.

Frame counter note: If you decide you want to remove the frame counter for some reason, it has backwards screw threads (i.e. turn clockwise to loosen). Several folks (including myself) snapped off the screw before learning this lesson. :(

H.1.2 Modification: Flash adapter

Thanks to: Mike Watters

RE: Kodak flash adapter- I don't hve any actually... The Kodak just has what used to be the standard bayonet flash plug. You could probably find one in a better camera store. OR you could hunt around for cheap old cameras that used the same bayonet that someone left the adapter on. OR... you can look for an old flash unit (tend to be about \$1 i thrift stores), they commonly could attach to either PC or bayonet fittings. Just cut the wires and make your own adapter...

H.1.3 Procedure: Kodak slow shutter mechanism

Thanks to: Mike Watters

It's REALLY common for the Kodak shutters to slow down. Unfortunately, the shutter is a real weak point since the camera is really pretty good besides that.

Try tripping the shutter a LOT. If you are lucky it will loosen up and work fine. (more common than we should ever let the camera dealers know. :)

Note: Mike provided two descriptions of his procedure for using graphite to fix the problem in two separate email messages. I have included both here.

In past I've gotten them working again by jetting in some dry graphite lubricant (made for locks mostly) directly onto the shutter mechanism. To do this you have to pull the camera half apart though (top, bottom, front center cover). You can then puff in the graphite from the hole in the center onto the gears and things situated around the right lens (i.e. the shutter itself). For cameras like the one described where they seem OK except for the low speeds being slow, that tends to work quickly and well.

If that doesn't work, the following will probably take care of things: You should pick up a tube of graphite powder at a hardware store. It will probably be in the auto section as it's used to lubricate locks. You'll need to pull the top off the

camera. Then you pull the front off. (via four screws, two on top, two on bottom). This should reveal a little window into the shutter mechanism from the front (where the viewfinder was). Trip the shutter a couple times so you can see where the moving parts are. Then tap in a small (gotta be careful here) amount of the graphite. Trip the shutter some more and see how it is now. More graphite as needed. If you use too much graphite you risk having it end up inside the lenses. That's cleanable, but bothersome. If that doesn't help the shutter probably would be fixed by soaking it in a solvent (I use acetone) to pull out the old lubricant then re-lubing with graphite.

Note: There was some discussion within the group about the merits of whether or not to lubricate the shutter mechanism before re-assembly. Advantages: reduction of wear and protection against rust. Disadvantages: The lubrication could act as a "trap" for dust, causing the problem to reappear. John Bercovitz contacted several repair experts. Here is a summary of what he found:

I called two places that do SLRs and three that do mechanical cameras. The SLR places can't believe anyone would clean a camera and not lube it while the mechanical places say don't lube the shutter. The best explanation came from Charlie Piper who said that the Kodak came with a lube on the leaf pivot points but it migrated onto the leaves and messed up the shutter speeds. So Charlie cleans them in his ultrasonic cleaner and leaves them dry. He does lube certain other points especially in the transport but the shutter stays dry. One of the SLR shops told me that the way you lube a camera is with a pin and an extremely small drop of oil. Sounds just like lubing a watch or a clock if you're familiar with that.

H.1.4 Procedure: Adjusting lens infinity focus

Thanks to: Mike Watters

How to determine how far to screw in lenses: What you need to refocus the lenses on a reference object (preferably infinity) while the camera is open on Bulb. All you do is remove the lens locking rings (the little rings around the lenses that say (35mm f3.5 etc.). This lets you turn the lenses (independently) and NOT turn the outer rings. You then use a small piece of ground glass back in the film plane (I've also used scotch tape), open the shutter on bulb and turn the lens until you focus each lens. Then you turn the outer rings so they read "infinity" (assuming the object you focused was at infinity) and replace the locking rings.

Another way to set the lenses at infinity is to loosen the four small screws on the front rings of the Kodak's lenses. That lets the lenses turn independent of their collars. Once you get infinity set, you just tighten the screws into the lenses again.

H.1.5 Procedure: Lens alignment - vertical

Thanks to: John Bercovitz

I have had some trouble with my Kodak 3D camera in that the left and right views didn't cover the same objects vertically. That is, you could see more at the bottom of one view than at the bottom of the other. This was easy enough to fix in mounting the stereo slides, but of course it gave fits to the Kodalux/Qualex automatic stereo slide mounting machines. Actually, they didn't worry about it at all; I was the one who was bothered. 8-)

It turns out that the Kodak is very simple to adjust. Between the shutter assembly and the camera body is a thick rubber gasket. The shutter assembly is held to the camera body by four long black screws. Actually, it's the heads of the screws which are long; the threaded ends are relatively short. All you have to do is to loosen those four screws, shift the shutter assembly, and retighten. I used a small piece of ground glass up against the film rails and a 7X loupe to see what the film would be seeing. The screws are located near the extreme corners of the film apertures or gates. If you open the back of the camera, you'll see them.

The compliance of the rubber gasket is also apparently what allows one to set the focus of the lenses at infinity. In my camera, the gasket material is old and not very plump or springy any more. So I actually had to bring the lenses a little closer to the film than I wanted in order to get the screws tight enough to hold the shutter assembly firmly against the camera body. It would have been trivial to change the rubber for fresh if I had wanted to go to the effort. As an alternative, I could have put in some shim stock next to the rubber. As it was, I really couldn't see much effect from overturning the screws the small amount I overturned them.

H.1.6 Procedure: Dismantling the Kodak Stereo

Thanks to: Alex Klein

What you need are some really good screwdrivers. Don't even try to fool around with your pocket-knife or cheap screwdrivers. This is all what I use to repair cameras:

1. Screwdrivers 1.0 mm, 1.5 mm, 2.0 mm, 2.5 mm, 3.0 mm, 5.0 mm
2. Phillips Screwdrivers PH 000, PH 00, PH 0
3. two pairs of tweezers (one straight, one slightly bent)
4. two good eyes and good hands
5. several empty film-containers for small parts

This description is not necessarily accurate. I wrote this purely from memory. Next time I take apart a Kodak, I should probably make a few notes.

It is unnecessary to remove the bottom part. Start with the top part. First, open the camera back and stuff some paper (Kleenex etc.) into the take-up spool (right). Make sure to push the paper upwards. This helps to prevent that parts are falling down into the camera. It's not really necessary as this is nothing "deadly", but it helps to save some time.

Then remove the wind and rewind-buttons by using a large screwdriver. Make sure not to mess-up the parts of the rewind-button. Then loosen the two phillips-screws at the outer end of the metal top plate. Remove the top plate.

At this stage, you could clean the back element lens of the viewfinder by opening the camera back and lifting off the small bakelite cover, but I suggest you wait with that until you start assembling the camera again.

Next, remove the diaphragm and shutter-speed dial by removing the two screws holding the appropriate part. The small lever with which you set the diaphragm is held by a tiny screw which has to be removed. Put the lever and the screw in a film container. If you get nervous about the size of the screws: this one is one of the smallest ones.

After that, remove the bakelite front part (the one with the Kodak-logo) by removing the two regular screws on the bottom (left and right of the serial number; the screws have fairly thick heads) and the two phillips-screws at the top (that's why you had to remove the top)

Then lay the camera on the back and remove the four phillips-screws holding the brown ring round the lenses (the one that says 'Kodak Anaston Lens'). The screws also go into a film container. Personally, I use just one big container, but you may wish to use several containers and label them. Numbering the containers is probably no bad idea. Then you know which parts to put where at the right time (working your way back to box #1).

The rings lift off pretty easy, probably you have to take a small screwdriver and lift them off (at one of the two holes, so you don't scratch anything). Next, screw the front elements of the lenses out. It's no bad idea to label them left and right (who knows, maybe they're matched??).

Then remove the two aluminum scales (depth-of-field [right]/arrow [left]).

Now it's time to remove the whole shutter assembly. Open the camera back and loosen the four rather big black screws (they're pretty long). The shutter assembly should fall out. There's NO danger of any hidden springs.

To open the shutter, remove the four bolt-like screws that held the aluminum scales (the screws protrude about 6 mm, so it's quite obvious which screws I mean. The left and right pairs are different. Have a close look!

Now you should have the shutter right in front of you. Describing the whole shutter mechanism exceeds both my memory and my English language skills, but it's quite obvious.

By the way: the shutter can be cocked with the protruding lever. If you want to fire it, a small latch (?) near the cocking lever must be pushed in one direction (hold it like that), then press the shutter release "button".

To clean the shutter, I'm using a special kind of benzine which I buy at the pharmacy. It's extra-clean, is usually used to clean wounds (in German, it's called "Wundbenzin" - wound benzine). It evaporates much faster than usual benzine and doesn't smell as badly. By washing the shutter, you remove all old grease and dirt. Then re-lube very carefully. Don't even try to lube the shutter blades...

By the way, I'm using the same stuff to clean lenses (with a special cotton- swab).

This description is really just very basic, but it should help you to fix MOST problems of the Kodak, to clean ALL lenses, the viewfinder (also all lenses and mirrors) and to re-focus the camera.

When assembling the camera, simply proceed "in the other direction". At the various stages, check the functions of the camera (i.e. after putting the shutter assembly back, cock the shutter and fire it. Once you screw in the front elements of the lenses (don't forget to clean them!), put a ground glass (scotch-tape of thuin glass) onto the film plane, cock the shutter, put it on B and screw-in a cable-release. Then keep the shutter open (diaphragm at f 3.5) and focus on a distant object (no accurate focusing at this early time). Then remove the cable-release and continue assembling the camera, but leave the two brown rings round the lenses away.

Everything on its place? Congratulations! Now it's time to focus the camera. Keep the shutter open, the diaphragm also. Turn the lens rings to the in- finity-position. Put one brown ring in place and SLIGHTLY turn in the two phillips screws. With your fine ground-glass and a good magnifyer (min. 25 x) adjust the focus to infinity. Then tighten the two screws. Do the same with the other lens. Cross-check the focus of the lenses at infinity. You may have to play around a bit, but you'll soon notice how it works. After re-focussing some 10 cameras, you can do it in 10 minutes.

H.1.7 Procedure: Problems with the cable-release

Thanks to: Alex Klein

Several Kodaks have problems with the cable-release which seems to "slip" over some lever when it's being pushed down. This is due to a small lever behind the cable-release-thread which is off-center.

There are two possibilities to fix it. One is the "traditional solution" which I usually prefer: you have to dismantle the camera and bend a lever inside the shutter mechanism (just a very slight adjustment will do since the "pin" of the cable release itself is only slightly thicker than 1 Milli- meter).

Unless you feel comfortable taking apart things like cameras or watches, I'd rather recommend that you keep your fingers off the shutter mechanism. If I had to repair it, it would take me about 1 to 1.5 hours - including cleaning of the lenses and re-focusing.

However, you MIGHT try the "quick solution" which usually works quite well.

Take the camera and a bright light (flashlight or even better a halogene lamp, the sun will do as well). Peek inside the tiny hole that's used to screw in the cable release (let the light shine in as well). You should notice a small lever somewhere on the back of the hole. In your case, the lever might very well be off-center (where it is supposed to be). If it's too far off-center, you might not even see it at this time. In the latter case, set the shutter-speed to B and cock the shutter. Then press the shutter release button and keep pressed. NOW you should see the lever.

All you need is a tiny little screwdriver to put through the hole and to bend the lever until it's in the center.

H.2 Realist Camera

NOTE: There were several models of Realist cameras made. Important to note is the "Realist 45", which is significantly different than other models. Unless otherwise specified, these procedures relate to the more common NON-REALIST 45 models.

H.2.1 Sources for Realist Parts and Repair Information

Repair Parts:

Ron Zakowski
RR2 Box 638
Oak Haven Circle
Wautoma, WI 54982-9740
USA
(414) 566-2323

(Ron is an engineer who helped design some of the things on the Realist and bought all Realist materials from the company when he retired. He is the source for replacement parts for Realist products)

Repair manuals: "Basic Training", "Realist Repair Manual"

Ed Romney
Box 96
Emlenton, PA 16373
(412) 867-0314

H.2.2 Procedure: Light leaks - camera back

Thanks to:

Symptoms: Occasional light leaks in the right-hand image. Not often, but enough to be annoying -- sometimes as many as one per roll of film, but not at any predictable place in the roll.

Solution 1: (contributor unknown)

Simply use some black tape to cover the back of the camera near the hinge.

Solution 2: (contributor unknown)

The source of the leak is right where the camera back closes next to the focus wheel. The standard fix is to peel some of that nice black light trapping material from the lip of an old 35mm film canister and glue a neatly trimmed sliver along the inside edge from top to bottom on the end where the focus wheel is. Makes a nice gasket for light-tapping.

Solution 3: (Martin Simon)

The light leak problem is common on the Realist. The latch on the right hand side (from the back) on the bottom has to be adjusted to hold the back on tighter.

Solution 4: (Joe Bakan)

There is an easy fix for this. With the camera closed, check for play between the back and the body at the right side (the side with the focus knob). To adjust the latch and eliminate the play (and the light leak), remove the back, and note the small metal tongue at the right side of the back that engages the latch and holds the back shut. With pliers, carefully bend the tongue SLIGHTLY in toward the center of the camera. Replace the back on the body, lock the latch and check again for play. Re-adjust as needed. When it fits snugly, no more light leak!

Solution 5: (Ed Comer)

I don't think that the suggestion of "bending tongue slightly towards the center" is the best way to tighten the seal. Instead, I'd suggest attempting to shorten the tongue by increasing, or moving, the tongue's end curl down shaft towards the body. It is the "hook" of the curl that catches the locking shaft, and how close the "curl hook" is relative to the body, appears to determine how tight the back's seal will be. Bending the tongue inwards won't really shorten the worn curl, although it would create a spring tension effect that would mitigate, but not eliminate the looseness. .

Ken Luker adds:

I made the adjustment described above because the latch was so loose the back fell completely off my camera, ruining three or four exposures. But I never experienced noticeable light leaks until AFTER I'd made the adjustment. Now I notice that the metal tab on the other end of the camera seems to be allowing too much play in the hinge end. I'm going to adjust that with pliers. I fear wiggling with it too much may loosen the rivet grips and then I'm sunk.

H.2.3 Procedure: Film advance clutch spring replacement

Thanks to: Ken Luker

Symptoms:

Replacement of the winding spool clutch spring on a Realist

The film advance mechanism of a Realist stereo camera has five main parts:

1. A slotted spool to hold the advancing film and which pulls the film through the camera. The spool has a flange on the top end, a slot into which the film tail is placed during film loading, a film-gripping spring within the hollow axis of the spool, and a small hole with an Allen set screw, to lock the spool onto a steel axle through its center, which turns to advance the film.
2. A drive axle through the center of the slotted spool. The axle fits through the top of the camera, passes through the clutch mechanism described below, then through the slotted spool and finally slips into a bearing hole in the bottom of the camera. The top of the axle extends above the camera and terminates in a small gear, fixed to the shaft firmly to allow the axle to be turned by the winding knob. When the axle is in place, only the gear at its top is visible. The axle has a flattened spot to bear against the Allen set screw which locks the spool to the axle.
3. A knurled winding knob, turning on a machine-screw axle and having a recessed underside. When in place, the knob is not centered on the drive axle described above, but it completely covers the exposed gear of the drive axle. An attached fixed gear within the recessed underside, concentric with the hub of the knob, has teeth facing outward which engage the gear at the top of the drive axle. When the knob is turned, the axle is driven in the opposite direction.
4. A tightly wound spring which fits around the drive axle just beneath the camera top, snugging tightly to prevent the axle from turning. Each end of the wire spring is turned outward, forming prongs that may be forced by levers in the direction that tends to unwind the spring. When that happens during film advance or rewind, the axle is freed for turning.
5. A clutch release washer, fitted on the axle just below the clutch spring and against the flange of the slotted winding spool. The washer has two protuberances and one groove: the inner rim of the washer is turned upward for about one third of its circumference, forming a boss that fits around part of the clutch spring. The outer rim of the washer has a small turned-up tooth that fits into a hole in a nearby lever, permitting the lever, during film advance, to pull the washer through a slight rotation and slightly unwind the spring. A radial groove extending outward from the inner rim forms a recess to hold one of the prongs of the clutch spring. The other prong of the clutch spring rests against a second lever which, during rewind, forces the spring into a slightly unwound position to allow the drive axle to rotate.

Function: The knurled knob turns the axle, which turns the spool, which pulls the film. The spring and washer serve as a lock and release mechanism. The spring grips the axle and prevents it from turning except during film advance and rewind, when the spring's prongs are moved slightly in the direction that tends to unwind the spring, thus freeing the drive axle. The method of loosening the clutch is different for advance and rewind. To advance the film, it is necessary

to press the film release button on the back edge of the top camera plate near the rewind knob. The button moves a lever to the left. This clutch lever has a small hole into which the tooth on the outer rim of the clutch release washer has been inserted. The lever pulls on the tooth, causing the washer to rotate slightly. One prong of the clutch spring is lying in the recessed groove of the washer, and as the washer rotates, the prong, caught in the groove, moves with the washer. Since the other end of the clutch spring is resting firmly against another lever, the spring unwinds slightly and allows the axle to turn. As the film advances during the winding, its sprockets pull a sprocket gear through one revolution. Partway into the revolution a cam holds the clutch lever in its leftward position, allowing the operator to release the button. As the revolution ends, the sprocket gear locks in place and the cam releases the lever, allowing the clutch spring to grip the drive axle again. To rewind the film, the advance/rewind disk on the top of the camera must be moved from A to R. This action frees the sprocket gear and allows the film to be pulled backward through the camera into the film cartridge. When the disk is turned to the R position, a rewind lever is also moved slightly to the left. Since the second prong of the clutch spring is resting against the rewind lever, the spring is slightly unwound and the axle is released for the rewind operation. Moving the disk to the A position allows the clutch spring to grip the axle tightly again.

Clutch Spring Replacement: When the clutch spring breaks (usually, one of the prongs breaks off), obtain a replacement spring. Remove the camera back. Remove the knurled winding knob by removing the machine screw that serves as its axle. Remove the Allen set screw in the slotted spool. Pull the steel axle out of the camera by lifting the gear with a small tool, gripping the gear and pulling upward, or by removing the bottom of the camera and pushing the bottom end of the axle out of its bearing hole. Removal of the axle frees the winding spool, the clutch spring and the clutch release washer. Save the broken clutch spring for bragging. Hold the camera upside down. Using tweezers, put the clutch spring in place by putting the longer, hooked prong between the rewind lever and the small cylindrical post on the left. The spring should be centered on the axle hole. Next, put the clutch release washer against the spring, with the second, shorter prong resting in the radial groove. The raised boss should be nestled against the body of the spring. Don't try to put the tooth of the washer into the film advance lever yet. Carefully insert the slotted winding spool, with its flange against the clutch release washer. Now, insert the steel axle up through the hole in the inverted camera, through the spring, washer and spool, and toward the bearing hole in the bottom. At some point, the clutch spring will meet the thick part of the axle, and some force will be needed to push the axle farther. At this point it may be helpful to use tweezers to put the tooth of the clutch release washer into the hole in the film advance lever. If this is done, then turning the advance/rewind disk to R will force the spring slightly open and allow the axle to move into final position. If the axle can be put into position without engaging the tooth and lever, then put the tooth into the lever's hole next. Replace the knurled winding knob. Finally, turn the knob until the flat spot on the axle is aligned with the key hole and replace the Allen set screw in the film advance spool.

H.3 Realist Viewer

Ted Papoulas writes:

A friend of mine has put together an extensive booklet full of viewer maintenance, repair and improvement tips for the Realist Viewer. Some supplies, transformers, repair services, etc. are also available. For info. contact:

G. Themelis
10243 Echo Hill
Brecksville, Ohio 44141

H.4 Nimslo Camera (Japanese-made model)

Note: A recommended reference for the Nimslo is the "*Guide to the Nimslo 3D Camera*" available from Reel-3D.

Thanks To: Kent C. Brodie

Note: you gotta be REAL careful.

H.4.1 Procedure: Removing the camera bottom

The bottom of the nimslo camera is quite easy to remove. First remove the batteries, then remove the three bottom screws. The bottom of the camera comes off quite easily. I have had to do this once, to help unjam the film-advance mechanism. (most of the “mechanics” of the film winder are down here.) I have not taken apart the mechanics.

H.4.2 Procedure: Removing the camera top

To remove the top, you must undo three screws:

1. First, remove the film advance lever. On top of the lever is a special screw with two small holes. You can buy the special wrench needed, or, you can use a pair of pliers holding two paper-clip ends at just the right distance apart. Turn the screw counter-clockwise and it should come out. Next, remove the lever and the two small silver “washers”. Set aside.
2. Next, remove the top of the film RE-winder handle. Pop it partway up, and, while holding the “film catch” (the part that usually sticks into the roll of film), turn the top counter-clockwise. It comes out easily.
3. The last part is the shoe. On top of the flash shoe is a thin metal clip that slides directly back. The FRONT of the clip must be “lifted” slightly before the clip can be slid back. After that is removed, there is one silver screw that holds the shoe in place. Remove it. (note: this actually holds part of the shoe, but more importantly, it's the only screw that truly keeps the top of the camera secure. The shoe is ALSO held in place, from UNDERNEATH, by two more screws)

Finally, being VERY careful, wiggle the top of the camera loose and pull it straight up. Do not pull hard or fast! There are two very small wires that are only about 2 inches long that connect the camera to the flash shoe-- if you pull too hard, you'll rip out the wires.

The entire reason for this operation was so I could re-secure the shoe. The flash shoe is ALSO held in place by two small screws that hold it in from the INSIDE of the camera. These screws fell out some time ago on my camera.

H.4.3 Procedure: Fixing problem causing completely unexposed rolls of film

Symptom: Unexposed rolls of film, shutter `_sounds_` like it is operating.

Solution 1: (Thanks to: John)

I just got a used Nimslo from a friend which would not fire. It turned out that the battery contact was not providing enough pressure against the cells (and the cover).

Solution 2: (Thanks to: Marty Hewes)

I had one that sounded fine but didn't expose. After prodding around with a voltmeter while referring to the schematic in the Nimslo book from Reel-3D, I found grunge on some “switch” contacts inside. The “switch” was made up of a wire that made contact with a post inside. A little rubbing alcohol on a Q-tip cleaned it right up.

H.5 ViewMaster Camera

H.5.1 Modification: Adapting a ViewMaster for Electronic Flash

Solution: (thanks to Vance Bass)

Regarding the addition of a PC connector to the Viewmaster camera: this camera was designed by the creator of the TDC Stereo Vivid (my all-around favorite “Realist”-type camera) -- it has the same feel ergonomically, and shares many design features including the dual guillotine shutter mechanism.

I modified mine and a friend's six or seven years ago with the addition of a PC plug at the 5-o'clock position on the front of the face. It was fairly simple, due to the fact that the contact mechanism is the first thing you can see when you remove

the bottom plate of the camera body. (The only caveat, in case you want to start, is to make a detailed drawing of how the contact goes together, because you'll have to remove a screw to do the soldering and it's not easy to see how it goes back.)

That said, I can say that it's also possible with a Viewmaster. The contact is essentially identical as I remember. There was a difference in the shutter timing, however, since the Vivid's shutters were timed to work with both bulbs and strobes, while the Viewmaster's were timed only for bulbs. A friend who added a PC contact to his Viewmaster camera ended up having to disassemble the shutters and trimming a little bit off the "finger" on the bottom of the shutter blade to slow down the closing of the contact. (Bulbs have to start firing a few milliseconds early so they're burning full strength when the shutter opens. A strobe's 1/10000 sec. comes and goes before the shutter starts opening on the Viewmaster.) This was a guy who built his own Realist macro cameras from spare parts, and he had a hell of a hard time getting it right, so I would warn that this is not a dead simple operation and also that you should query your technician carefully about what is planned, how it's to be accomplished, and how it will function.

H.6 Busch VerascopeF40 Camera

H.6.1 Procedure: Reduction of internal reflections

This is a copy of an application note written by David Burder (copy provided by Stephen Spicer)

IMPROVING THE BUSCH VERASCOPE F40 STEREO CAMERA (By David Burder, August 1987)

Whilst the vast majority of 35mm stereo cameras have a 5 perforation format (24x23), the Verascope F40 and the Belplasca are the two most common cameras offering the wider 7 perf (24x28) film area. (The Iloca I is another 7 perf camera - SS)

Both cameras have their own respective pros and cons: for example, the Belplasca gives crisp and contrasty images from its Tessar lenses, but lacks a range-finder, feels cheap and has no flash shoe, only a standard co-ax socket on the cameras bottom!. In comparison the F40 looks and feels really solid, has an excellent range-finder, a standard cold flash shoe on the top plate but a pair of totally non-standard flash sockets. The only snag I have found is that the results were pretty appalling; the images were gutless, soft and lacking contrast. Only with flash did the pictures start to look decent. Having owned three of these cameras, I decided that something should be done to achieve better results.

Jumping in at the deep end, I removed the French Flor lenses and replaced them with 40mm Rollei Triotars from the baby Rollei compact camera - the results were better but not good enough so I started to look around from a pair of Tessars or Sonnars from the more expensive models. Meanwhile, I found a pair of Olympus 4 element lenses and fitted these. But still the results were not as bright as those of the Belplasca so I decided to see if there is something inherently wrong about the camera itself. There is! The whole design of the camera interior is bound to give appalling flare, thereby reducing contrast and generally degrading the image. The shape of the body cavity force all non-image forming rays back onto the film plane destroying the quality of the picture. To prove how bad this is, just put the camera on B and look through the back at a strong light.

The solution was not difficult; firstly I machined an exactly matching pair of lens hoods; rectangular in shape to stop all unwanted light from entering the camera. These were designed to work 100% efficiently when focussed at maximum close up and maximum aperture, even though this means they became a bit less efficient as aperture and focus were reduced.

The second part of the solution which is also not difficult for the handyman, is to remove the solid aluminium film plane panel (5 screws) and file away the sloping channels until the camber angle is reversed. At the same time the window can be slightly opened up to give a slightly deeper image area on the film, always useful when mounting. The surface should now be painted matt black. When the film plane channel is removed, various bits and pieces will fall out but these can be happily discarded as they are only the dangerous metal slide which is used to blank off the right frame when doing sequentials (The F40 can be used to expose 20 stereo pairs or 40 mono photos on a 36 exp roll - SS). However, it will still be necessary to ensure that the control knob on the top plate is pointed on the stereo (not mono) position in order for the 1-3-1-3 wind on system to work correctly.

David Burder, August 1987

H.7 Sputnik Camera

H.7.1 Procedure: Shutter Adjustment

Thanks to: John Bercovitz

I recently bought a Sputnik that was in beautiful shape although it did have a small adjustment problem in the shutter. Since I have just finished opening it up to get at the shutter, I thought I might share what I learned. First of all, the Sputnik is a very simple camera and I can't think of anyone whom I would warn against working on it. 8-)

There are three lenses in a row on the front of the Sputnik and they are all geared together so obviously the center one turns anticlockwise when the outer ones turn clockwise. The center lens is the finder lens and it focuses the finder image on the ground glass. It has a reverse thread. For adjustment, it has a band with distances marked on it and two tiny set screws which can be loosened to allow that band to rotate free of the lens.

This lens' gear is attached to the lens directly and although I don't immediately see a way to loosen that connection, it is not required to do so.

The left and right picture-taking lenses have gears which mesh with the finder lens' gear. These gears are clamped to the left and right lenses by tiny set screws much as the finder lens' distance band is clamped to the finder lens. However, if you loosen a taking lens gear's set screws far enough, you can remove the gears right off the front of the lenses. These three set screws per gear are found equally spaced around the periphery of the gear boss and have axes which are perpendicular to the axis of the lens.

The shutter timing mechanism is in the right taking lens assembly. The left lens' shutter is operated by a lever connecting it to the right lens' shutter. After removing the gear from the right lens, you will see a D-shaped cam which takes a two-pin spanner or a pair of fine-tipped needle-nose pliers to rotate it. The idea is to rotate the cam until its rounded section is out of the rounded cut in the shutter assembly. Having done that, you can now rotate the plate on which the D-cam is mounted until its locking tabs line up with the rounded cuts in the shutter assembly.

When the locking tabs are lined up, you can remove that plate and then the shutter timing mechanism will be exposed. The top plate-cam you will see now is the shutter speed selector. It just lifts off. If you turn it to B it can be replaced easily. An interesting thing I learned is that there is an unmarked cam position between 1/60 and 1/125 second. I wonder if it is 1/90. I will measure its speed when I get a chance.

As you may have been able to infer from the discussion, this camera uses front-cell focusing. As long as the opportunity presented itself, I cleaned off the forty-year-old grease and relubed with a non-migrating silicone grease.

H.8 Twin Camera Arrangements

H.8.1 Nikon Lite-Touch

Twins with a Lite-Touch

by Edward I. Comer

January 8, 1994

While I enjoy using my Realist, and appreciate its quality results, I have experienced a growing frustration with getting its odd format film developed. This frustration eventually convinced me that, at least for some of my stereo work, I needed to migrate to the modern 35mm format.

Purchasing one the German "Siamese" twin cameras exceeded my stereo budget. Besides, I really enjoy building things myself. Therefore, my logical conclusion was to "twin" a pair of standard 35mm cameras. My desire to keep the camera's bulk and weight as close to the Realist as possible, eliminated the possibility of using SLRs. It appeared that a "Point & Shoot" was my best choice. Various pundits advised me that my best course was to twin an old pair of Olympus XA2s. After all, twin-ing the old XA2 was a low cost, mature, successful method.

Too easy. I also wanted to break new ground. I felt that if I twinned a current production camera, and propagated instructions on how to duplicate my effort, then the availability of modern featured stereo equipment would expose

more people to the joy of stereo photography. After all, the supply of XA2 cameras isn't going to last forever. Thus I decided to select the smallest, most recently introduced "Point & Shoot" with an electronic shutter.

My search didn't take long. Long a fan of Nikon equipment, the recently introduced Nikon Lite-Touch looked like it would satisfy most of my requirements. It has a well rated 28mm f/3.5 triplet, electronic everything, built-in flash, and it is tiny. It has a panorama mode switch, but all it really does is drop shutters that mask the top and bottom of the already wide angle image.

I bought one camera, deciding to wait to purchase the second until I had verified my ability to access and modify the necessary electronic circuits. My first obstacle was mechanical. The camera's heavily torqued phillips screws eluded my attempts to remove them. My workshop grade screwdrivers weren't going to do the trick. Fortunately, my local hobby shop had just what I needed; a superb quality, miniature phillips screwdriver made by the German firm "Wiha". It removed the camera back screws like they were embedded in butter.

Figuring out which of the numerous screws to remove is an accomplishment that I'll pass along, and let you benefit from my experience. There are four that need to be removed to release the clamshell across the top and sides. I'll list each screws location reference as viewed from the camera's back:

1. Remove the short screw from the upper right corner of the camera back.
2. Remove the short screw just below the back release, on the camera's left side.
3. Remove the medium length screw beside the wrist strap loop, on the camera's right side.
4. Remove the long screw near the tripod mount on the right side of the camera's bottom.

Remember or record each screw's origin, for they are of varying lengths.

The top clamshell will still be held with little catches. Slightly tilt out and up the right side, and the center portion of the left side. Once both sides are free, the entire top shell is tilted up and will fall free. Now the fun begins.

Still viewing from the camera's back, notice that you have exposed the shutter contacts. They are the gold plated printed circuit board circles on the top right side. They look sort of like circles of interlaced fingers. There are three contact circles in a row near the front side of the top right. The center contact circle is the "shutter", and the contact circles on each side are duplicated "focus" contacts. Near these, to the right and toward the camera's back is another contact circle. This is the manual rewind button's contact. The focus contacts are duplicated due to the design of the shutter button. Pick up the plastic clamshell and take a look at it. The shutter release is a hollow rubber oval with three rubber posts on the underside. Look carefully and you'll notice that the outer two posts are longer than the center post. If you utilize an ohmmeter, you'll also discover that the posts are electrically conductive. When the shutter release button is pressed, the outer two posts will contact their associated interlaced contact circles before the center post. This is the half way focus position. When the electrically conductive rubber post contacts the interlaced contact circle's fingers, it electrically shorts the fingers and fires the focus function. Continued downward pressure on the shutter button brings the center post into contact with its contact circle and fires the shutter.

Our objective is to connect wires to the "focus" and "shutter" contacts, as well as their electrical "common", do the same to a second camera, and then wire the two together. I used a stranded 28 gauge ribbon cable, stripping out a three wire slice. I found that 28 gauge is really too large. Use 30 gauge wire, if you can find it. You cannot connect directly to the contact finger circles, as this would ruin the shutter button's functionality. Therefore, you must follow the contact's printed board trace towards the left, and get out of the release button's path. This isn't entirely achievable, and you'll have to cut a small chunk out of the release button rubber edge, which I'll describe later. You'll need to scrape a small amount of the green solder mask from the trace, in order for the solder to adhere.

Use as small a soldering iron as you can. Mine is an UNGAR-matic soldering station designed for printed board work, and it was still too large to easily control. Tin the wire terminus and the prepared trace, apply a little solder flux to the wire, mate the two and briefly apply the iron to bond them. This is delicate work, and the only time that I was concerned that I'd mess up the camera. However, I was overly concerned and was completely successful. After you have connected the "focus", "shutter" and "common", you are almost ready to reassemble the camera.

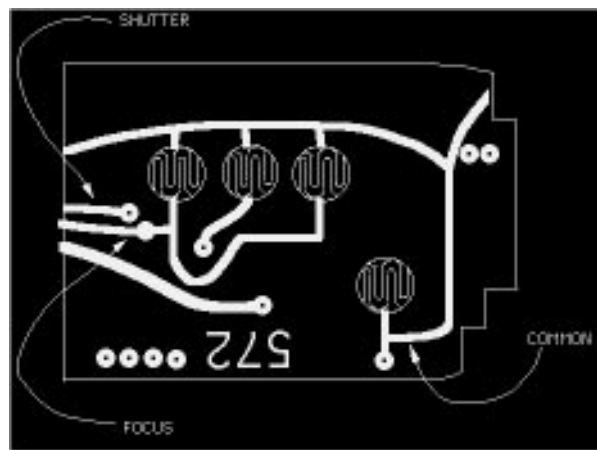

Using a small file, I removed enough plastic from the top right hinge area to allow the ribbon wire to exit the camera case, once reassembled. You are now finished with the soldering work, so reverse your steps and put the cameras back together.

I plan for my final mount to be adjustable so I can change the stereo window, but initially I prepared a piece of maple yardstick to serve as the mount. The bottom of the Lite-Touch has a protruding base that made it very easy to assure perfect alignment. I used a router to cut two cavities (3/4" x 3 3/4" x 3/32") into the wooden mount. Each camera perfectly nestles into a cavity and is secured with a bolt through the wood, into the tripod mount. The main body of the camera clears the cavity's lip, thus they can stay on the mount during film loading/unloading. About the only time that they must come off the mount is to change batteries.

The ribbon wire is dressed and secured with Velcro to run down one camera edge, along the wooden mount, and back up the second camera. I inserted a 3 conductor jack & plug in the middle, so that I could separate the cameras, if necessary.

I haven't tested the synchronization between the two shutters, but they seem to be perfectly in sync. I've taken flash and daylight shots of moving people and automobiles, and sync seems fine. Initial tests validate my calculations that the nearest object should be no closer than nine feet. So far, I've only used prints viewed with a View-Magic viewer. I found that with photos where the nearest object is at or beyond nine feet, I can mount the two prints with identical horizontal alignment. However, when an object is closer than nine feet, I must skew the horizontal alignment to obtain a comfortable stereo window. The formula provided by David Kuntz in the ISU STEREOSCOPY number 12 is:

where:

$$\frac{i \cdot b}{p} = n$$

- i = focal length, in mm.
- b = baseline, in feet
- p = parallax (1.2mm for infinity far point)
- n = near point, in feet.

Enjoy!